



interstuhl

INDIVIDUAL SELECTION



2023 PRICES – DATA – VALID AS OF 1ST JANUARY, 2023

ENJOY SEATING PERFORMANCE. 

CONTENTS

Introduction	Explanation of price lists	2
	How it all began	3
	Splaces	4/5
	SPRINT	6/7

visitor chairs, conference chairs	Performance class IS7	Silver	8	
	Performance class IS5	VINTAGE ^{IS5}	18	
Performance classes IS1: Sturdy Interstuhl brand product. Materials and functions correspond to performance. Straightforward design. IS3: High functionality and ergonomics with distinct design. IS5: Products with outstanding design and high requirements for unique functions and excellent ergonomics IS7: Milestones in engineering, design and efficiency that shape the entire brand.	IS5	Champ	26	
	IS5	AirPad	32	
	IS5	Hero	38	
	Performance class IS3	PURE ^{IS3}	44	
	IS3	JOYCE ^{IS3}	48	
	IS3	Goal-Air	68	
	IS3	Goal	74	
	Performance class IS1	AIM ^{IS1}	82	
	IS1	EVERY ^{IS1}	98	
	Performance class IS5	TWENTYFOUR ^{IS5}	118	

Communication areas For more information about mechanisms, functions and the operation of our products, visit interstuhl.com/productinformation	WHAT IF WE FLY	124		
	HUB	148		
	Performance class IS5	TANGRAM ^{IS5}		186
	IS5	LEMON ^{IS5}		192
	IS5	LIME ^{IS5}		198
	IS5	KINETIC ^{IS5}		204
	Performance class IS1	UP ^{IS1}		210
	Performance class IS3	BUDDY ^{IS3}		216
	IS3	VLEGS ^{IS3}		226
	Performance class IS1	SHUFFLE ^{IS1}		248
IS1	MONO ^{IS1}	274		
Performance class IS3	Fascino-2	280		
IS3	NESTY ^{IS3}	288		

General information	Accessories	294
	General Terms and conditions of business	298
	Warranty	301
	Care instructions / Cover fabrics	302
	Cover fabrics / Surfaces	304





Traditional roots and innovative growth: Brothers and managing partners Helmut Link (left) and Joachim Link (top) are leading Interstuhl into the future.

INDIVIDUAL SELECTION



THE COMPLETE RANGE FOR INDIVIDUAL REQUIREMENTS

One of the aspects that makes Interstuhl so special is the flexibility and variety of its portfolio. Therefore, we of course continue to offer an extensive array of models, designs, materials and colours. With the **Individual Selection**, our partners and customers have a wide range to choose from within each collection – just as they always have done.



The Individual Selection is available to download in PDF format from the Interstuhl Partnernet: interstuhl.com/partnetnet

INTERSTUHL PLANNING DATA

EVEN MORE CONVENIENCE THANKS TO OAP! CONFIGURE DIRECTLY ON THE PRODUCT!

All commercial and graphical data from the Individual Selection is available in pCon.update. Thanks to OAP (OFML Aided Planning), using our planning aids is now even more convenient and intuitive. With immediate effect, it is now possible to make modifications directly on the 2D/3D model, even on complex products such as HUB configurations.



For further information, visit interstuhl.com/planning

FROM SWABIAN BLACKSMITHS TO INTERNATIONAL SUPPLIERS OF QUALITY PRODUCTS.

Interstuhl's story of success began in 1961 when two blacksmiths in the Swabian Jura started tinkering – as Swabians are wont to do. With their passion, expertise and hard work, they built the first chair to revolutionise the working world and take the strain off the human body.

What began as a joint venture between father and son 60 years ago is now a family of around 850 committed employees worldwide. Based in Tieringen, a district of the German town of

Meißenstetten, we are now one of the leading manufacturers in Europe. From our home, we supply the entire world with sophisticated and innovative products "Made in Germany".

Our knowledge and expertise, as well as our high quality standards and innovative spirit, drive us to continue achieving excellent results every single day. We always have a clear goal in mind: Offering our customers the best possible solution for their requirements.



For more information about our company, visit interstuhl.com



Splaces

SPLACES: WHAT'S IN A NAME?

SPLACES IS OUR ECOSYSTEM FOR NEW WORK

With Splaces, we confront the challenges of a new time, a new form of cooperation and a new world of work with a holistic concept.

To do this, we combine knowledge from the fields of architecture, science and user requirements with our many years of experience in the office environment. The objective is to identify and understand the challenges and requirements of the modern world of work and offer solutions that enable our customers – and all those involved in creating New Work Spaces – to write their own personal New Work stories.



Do you want to know more?
Visit interstuhl.com/splaces for
all the information about our
Splaces ecosystem.

HOW DOES THE IDEA OF SPLACES BECOME A TANGIBLE CONCEPT?

Together, we will develop a shared understanding for your starting point, your requirements, your wishes and goals. That means: We will ask questions, challenge existing beliefs, listen, observe and provide advice. We will jointly develop a clear definition of your personal New Work vision.

We achieve this by examining two components – architecture and ideas. The first consists of analysing stock and requirements. The second component is examined in a series of workshops and by surveying those who will later work in the new environment. In doing so, we only employ those components that are actually needed based on your current development status.

The results are evaluated and then prepared to serve as a basis for the subsequent planning phase.



Do you want to know more?
Visit interstuhl.com/splaces for
all the information about Splaces,
our new area of expertise.



On your chairs, get set, go! Welcome to the INTERSTUHL SPRINT express range. With Interstuhl SPRINT, you benefit from tried-and-tested models with extra-fast availability, optimum price-performance ratio, and 10-year guarantee. The maximum order quantity is limited to 40 chairs per customer per week.

With Interstuhl SPRINT, you benefit from preconfigured, tried-and-tested best-selling products with extra-fast availability, and a 10-year guarantee.



INTERSTUHL
SPRINT-DAILY
ORDER TODAY.
READY FOR DISPATCH
TOMORROW.

INTERSTUHL
SPRINT-WEEKLY
CONFIGURED
AS REQUIRED.
READY FOR DISPATCH
WITHIN ONE WEEK.



[interstuhl.com/sprint](https://www.interstuhl.com/sprint)

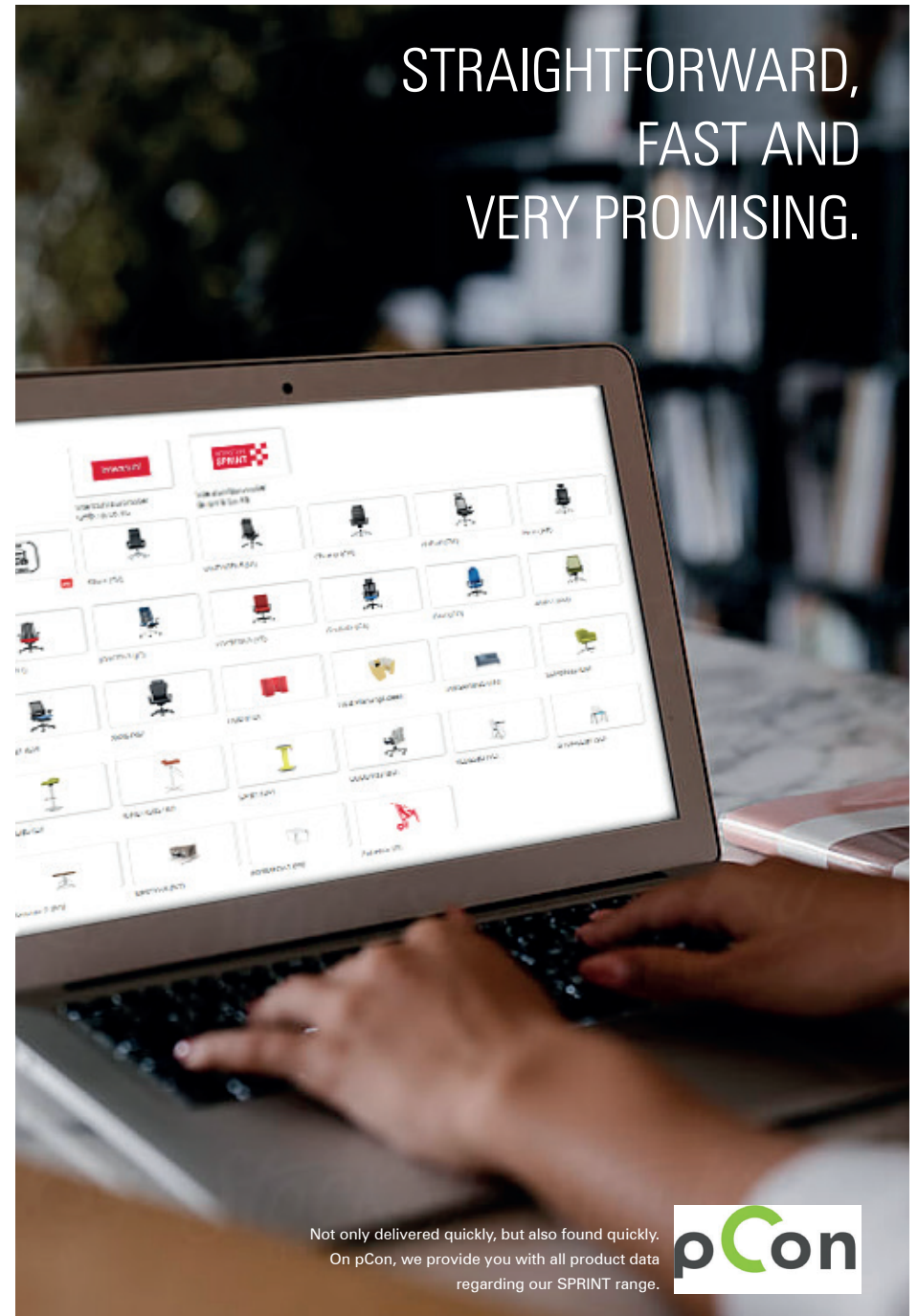

STRAIGHTFORWARD,
FAST AND
VERY PROMISING.

Not only delivered quickly, but also found quickly.
On pCon, we provide you with all product data
regarding our SPRINT range.





WT104



WT108



WT206

Quality:



Tested safety



Warranty (10 year)

Environment:



Tested for contaminants

Product design Frank Hesselmann, Berlin

WHAT IF WE FLY
TASKBOARD

Standard:

- White whiteboard
- Chip board with birch Multiplex edge
- Both sides magnetic, can be written on
- Pen tray
- Natural wooden feet made from ash, untreated
- Universal castors, lockable

	
TASKBOARD W M 120 Medium whiteboard	TASKBOARD W XL 240 Large whiteboard
WT101	WT102
Seat mm: H: 1035, W: 1200 Total mm: H: 1910, W: 1200 D: 620	Seat mm: H: 1035, W: 2400 Total mm: H: 1910, W: 2400 D: 620
Weight: 37,4 kg	Weight: 60 kg

Basic equipment ● / options ○		Colour	Order No	Price in €	Price in €
Basic price	Basic equipment			1350	1900
Colours	Powder-coated steel parts	white	2283	●	●
		black	2217	○	○
Surface	Magnetic, can be written on	white	47P7M	●	●
Frame	Wood, untreated	natural ash	5T1462	●	●
Castors	Universal castors, lockable	electrogalvani	891319	●	●

WHAT IF WE FLY



FLYNOTES L
Wipe-clean note plates
5 pieces
(blue-206; red-207;
yellow-208; green-245)

WT903

19 €



FLYNOTES XL
Wipe-clean note plates
5 pieces
(blue-206; red-207;
yellow-208; green-245)

WT904

29 €



FUNCTIONAL HOOKS
black - 2217
white - 2283

WT908

45 €

Order example: standard version with various optional extras

Minimum order information/Options (O)

WT101	/	2217
Basic model		Colour finish/ Metal parts

Recommended price in € exclusive of VAT

**WHAT IF WE FLY
TASKBOARD**

Standard:

- MDF board, direct melamine coating
- Birch Multiplex edge
- Both sides covered with felt, suitable for hook-and-loop fastenings
- Pen tray
- Natural wooden feet made from ash, untreated
- Universal castors, lockable



TASKBOARD F M 120 Medium felt board		TASKBOARD F XL 240 Large felt board	
WT103		WT104	
Seat mm H: 1035 W: 1200	Total mm H: 1910 W: 1200	Seat mm H: 1035 W: 2400	Total mm H: 1910 W: 2400
D: 620		D: 620	
Weight: 30,6 kg		Weight: 48 kg	

Basic equipment ● / options ○		Colour	Order No	Price in €	Price in €
Cover	SGF - Felt			990	1250
Colours	Powder-coated steel parts	white	2283	●	●
		black	2217	○	○
Surface	Directly coated chip board with birch Multiplex edge	white	41A7M	●	●
Frame	Wood, untreated	natural ash	5T1462	●	●
Castors	Universal castors, lockable	electrogalvani	891319	●	●

WHAT IF WE FLY



FLYCHART L
Whiteboard panel
with hook-and-loop backing

WT901

210 €



FLYCHART XL
Whiteboard panel
with hook-and-loop backing

WT902

270 €



FUNCTIONAL HOOKS
black - 2217
white - 2283

WT908

45 €

Order example: standard version with various optional extras

Minimum order information/Options (O)

WT103	/	2217
Basic model		Colour finish/ Metal parts

Recommended price in € exclusive of VAT

WHAT IF WE FLY
TASKBOARD

Standard:

- White whiteboard
- Chip board with birch Multiplex edge
- Magnetic surface, can be written on
- Pen tray

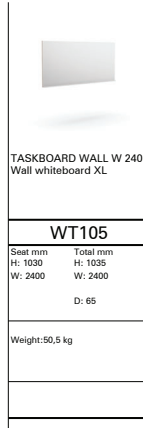

TASKBOARD WALL W 240
Wall whiteboard XL

WT105

Seat mm Total mm
H: 1030 H: 1035
W: 2400 W: 2400

D: 65

Weight: 50,5 kg

Basic equipment ● / options ○		Colour	Order No	Price in €
Basic price	Basic equipment			1200
Colours	Powder-coated steel parts	white	2283	●
		black	2217	○
Surface	Magnetic, can be written on	white	47P7M	●

WHAT IF WE FLY



FLYNOTES L
Wipe-clean note plates
5 pieces
(blue-206; red-207;
yellow-208; green-245)

WT903

19 €



FLYNOTES XL
Wipe-clean note plates
5 pieces
(blue-206; red-207;
yellow-208; green-245)

WT904

29 €

Order example: standard version with various optional extras

Minimum order information/Options (O)

WT105 / 2217
Basic model Colour finish/
Metal parts

Recommended price in € exclusive of VAT

WHAT IF WE FLY
TASKBOARD

Standard:

- MDF board, direct melamine coating
- Birch Multiplex edge
- Felt, suitable for hook-and-loop fastenings
- Pen tray

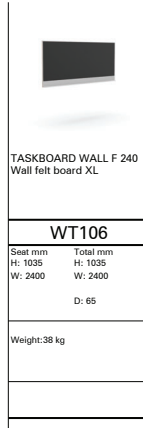

TASKBOARD WALL F 240
Wall felt board XL

WT106

Seat mm Total mm
H: 1035 H: 1035
W: 2400 W: 2400

D: 65

Weight: 38 kg

Basic equipment ● / options ○		Colour	Order No	Price in €
Cover	SGF - Felt			490
Colours	Powder-coated steel parts	white	2283	●
		black	2217	○
Surface	Directly coated chip board with birch Multiplex edge	white	41A7M	●

WHAT IF WE FLY



FLYCHART L
Whiteboard panel
with hook-and-loop backing

WT901

210 €



FLYCHART XL
Whiteboard panel
with hook-and-loop backing

WT902

270 €

Order example: standard version with various optional extras

Minimum order information/Options (O)

WT106 / 2217
Basic model Colour finish/
Metal parts

Recommended price in € exclusive of VAT

WHAT IF WE FLY
MONITOR ON WHEELS

Standard:

- Prepared with VESA mount for monitors with a screen size of 55" to 75"
- Laptop brackets for attachment on the side
- Natural wooden feet made from ash, untreated
- Universal castors, lockable



MONITOR ON WHEELS
TV stand

WT107

Total mm
H: 1730
W: 1770
D: 710

Weight: 52 kg

Basic equipment ● / options ○		Colour	Order No	Price in €
Basic price	Basic equipment			1250
Colours	Powder-coated steel parts	white	2283	●
		black	2217	○
Frame	Wood, untreated	natural ash	5T1462	●
Castors	Universal castors, lockable	electrogalvani	891319	●

WHAT IF WE FLY



MOV:E
Mobile power supply

WT906

1250 €



DOCKINGSTATION

WT907

79 €

Order example: standard version with various optional extras

Minimum order information/Options (O)

WT107 / 2217
Basic model Colour finish/
Metal parts

Recommended price in € exclusive of VAT

WHAT IF WE FLY
TEAMBOARD

Standard:

- MDF board, direct melamine coating
- Birch Multiplex edge
- Both sides covered with felt, suitable for hook-and-loop fastenings
- Natural wooden feet made from ash, untreated
- Universal castors, lockable



TEAMBOARD F M 700
Medium felt board with
storage compartment

WT108

Seat mm	Total mm
H: 1075	H: 1975
W: 700	W: 700
D: 135	D: 630

Weight: 33,6 kg

Basic equipment ● / options ○		Colour	Order No	Price in €
Cover	SGF - Felt			990
Colours	Powder-coated steel parts	white	2283	●
		black	2217	○
Surface	Directly coated chip board with birch Multiplex edge	white	41A7M	●
Frame	Wood, untreated	natural ash	5T1462	●
Castors	Universal castors, lockable	electrogalvani	891319	●

WHAT IF WE FLY

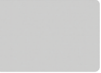

FLYCHART XL
Whiteboard panel
with hook-and-loop backing

WT902

270 €



FUNCTIONAL HOOKS
black - 2217
white - 2283

WT908

45 €



FLYCHART L
Whiteboard panel
with hook-and-loop backing

WT901

210 €

Order example: standard version with various optional extras

Minimum order information/Options (O)



WT108	/	2217
Basic model		Colour finish/ Metal parts

Recommended price in € exclusive of VAT

WHAT IF WE FLY
TEAMSHELF & TEAMDESK

Standard:

- MDF board, direct melamine coating
- Birch Multiplex edge
- Front edges with fleece strip suitable for hook-and-loop fastenings (WT109 only)
- Natural wooden feet made from ash, untreated
- Universal castors, lockable

	
TEAMSHelf Shelf with fleece strip and storage compartment	TEAMDESK Desk with storage compartment for FLYCHARTS
WT109	WT205
Seat mm H: 1075 W: 1080 D: 380	Total mm H: 1975 W: 1080 D: 630
Dimens. mm H: 1040 W: 1075 D: 700	
Weight: 63 kg	Weight: 38,2 kg

Basic equipment ● / options ○		Colour	Order No	Price in €	Price in €
Basic price	Basic equipment			1250	890
Colours	Powder-coated steel parts	white	2283	●	●
		black	2217	○	○
Surface	Directly coated chip board with birch Multiplex edge	white	41A7M	●	●
Frame	Wood, untreated	natural ash	5T1462	●	●
Castors	Universal castors, lockable	electrogalvani	891319	●	●

WHAT IF WE FLY

FLYCHART L Whiteboard panel with hook-and-loop backing
WT901
210 €

FLYCHART XL Whiteboard panel with hook-and-loop backing
WT902
270 €

Order example: standard version with various optional extras

Minimum order information/Options (O)

WT205	/	2217
Basic model		Colour finish/ Metal parts

Recommended price in € exclusive of VAT

WHAT IF WE FLY
SIT AND STAND BOX

Standard:

- MDF board, direct melamine coating
- Birch Multiplex edge
- Standing desk and two-person bench with storage compartment on castors



SIT AND STAND BOX
Box with storage compartment

WT206

Dimens. mm H: 1040
W: 490 D: 450

Weight: 27,4 kg

	Basic equipment ● / options ○	Colour	Order No	Price in €
Basic price	Basic equipment			450
Surface	Directly coated chip board with birch Multiplex edge	white	41A7M	●
Castors	Hard castors	black	882217	●

WHAT IF WE FLY
HIGH TABLE

Standard:

- MDF board, direct melamine coating
- Birch Multiplex edge
- Natural wooden feet made from ash, untreated
- Universal castors, lockable

	
HIGH TABLE L 1600 High desk	HIGH TABLE XL 2000 High desk
WT201	WT202
Dimens. mm H: 1040 W: 1600 D: 630	Dimens. mm H: 1040 W: 2000 D: 630
Weight: 41,5 kg	Weight: 50 kg

Basic equipment ●/options ○		Colour	Order No	Price in €	Price in €
Basic price	Basic equipment			800	900
Colours	Powder-coated steel parts	white	2283	●	●
		black	2217	○	○
Surface	Directly coated chip board with birch Multiplex edge	white	41A7M	●	●
Frame	Wood, untreated	natural ash	5T1462	●	●
Castors	Universal castors, lockable	electrogalvani	891319	●	●

WHAT IF WE FLY



MOV:E
Mobile power supply

WT906

1250 €



DOCKINGSTATION

WT907

79 €

Order example: standard version with various optional extras

Minimum order information/Options (O)

WT	2	0	2	/	2	2	1	7
Basic model					Colour finish/ Metal parts			

Recommended price in € exclusive of VAT

WHAT IF WE FLY
HIGH-/FOLDING TABLE

Standard:

- Folding tables
- MDF board, direct melamine coating
- Birch Multiplex edge
- Natural wooden feet made from ash, untreated
- Universal castors, lockable

	
HIGH-/FOLDING TABLE L 1600 Folding desk	HIGH-/FOLDING TABLE XL 2000 Folding desk
WT203	WT204
Dimens. mm H: 1040 W: 1600 D: 800	Dimens. mm H: 1040 W: 2000 D: 800
Weight: 44,5 kg	Weight: 55 kg

Basic equipment ● / options ○		Colour	Order No	Price in €	Price in €
Basic price	Basic equipment			1250	1350
Colours	Powder-coated steel parts	white	2283	●	●
		black	2217	○	○
Surface	Directly coated chip board with birch Multiplex edge	white	41A7M	●	●
Frame	Wood, untreated	natural ash	5T1462	●	●
Castors	Universal castors, lockable	electrogalvani	891319	●	●

WHAT IF WE FLY



MOV:E
Mobile power supply

WT906

1250 €



DOCKINGSTATION

WT907

79 €

Order example: standard version with various optional extras

Minimum order information/Options (O)

WT	2	0	3	/	2	2	1	7
Basic model					Colour finish/ Metal parts			

Recommended price in € exclusive of VAT

WHAT IF WE FLY
GRANDSTAND

Standard:

- MDF board, direct melamine coating
- Birch Multiplex edge
- Universal castors, lockable

	
GRANDSTAND 2 Seating element with two steps	GRANDSTAND 3 Seating element with three steps
WT301	WT302
Total mm H: 850 W: 735 D: 1180	Total mm H: 1300 W: 735 D: 1770
Weight: 60 kg	Weight: 81,2 kg

Basic equipment ● / options ○		Colour	Order No	Price in €	Price in €
Basic price	Basic equipment			990	1250
Surface	Directly coated chip board with birch Multiplex edge	white	41A7M	●	●
Castors	Universal castors, lockable	electrogalvani	891319	●	●

WHAT IF WE FLY

RAILING black - 2217 white - 2283
WT303
200 €

Recommended price in € exclusive of VAT



HU380



HUM65



HU132

Quality:



Warranty (10 year)



Tested safety

Environment:



Quality produced for the environment



Tested for contaminants









The Blue Angel
www.blauer-engel.de/uz117

Product design Volker Eysing, Kiel

HUB 1
Armchair ³

Standard:

- Inner seat shell upholstered
- Outer seat shell in Zaha (functional fabric)

					
HUB 1 low, armchair low, three-legged base	HUB 1 low, armchair low, four-legged wooden base	HUB 1 low, armchair low, swivel seat shell, four star base	HUB 1 high, armchair high, three-legged base	HUB 1 high, armchair high, four-legged wooden base	HUB 1 high, armchair high, swivel seat shell, four star base
HU130	HU140	HU100	HU132	HU142	HU102
Seat mm H: 370 W: 515 D: 510	Total mm H: 675	Seat mm H: 365 W: 515 D: 510	Total mm H: 675	Seat mm H: 365 W: 515 D: 510	Total mm H: 675
W(Ar) 940 D: 720	Backrest H: 285	W(Ar) 830 D: 670	Backrest H: 285	W(Ar) 940 D: 720	Backrest H: 435
Fabric needed (W:140 cm) Fabric:1,10 rm Leather needed:2,00 m ²	Fabric needed (W:140 cm) Fabric:1,10 rm Leather needed:2,00 m ²	Fabric needed (W:140 cm) Fabric:1,10 rm Leather needed:2,00 m ²	Fabric needed (W:140 cm) Fabric:1,50 rm Leather needed:2,50 m ²	Fabric needed (W:140 cm) Fabric:1,50 rm Leather needed:2,50 m ²	Fabric needed (W:140 cm) Fabric:1,50 rm Leather needed:2,50 m ²

Double socket cable length 1,90 m black - 3217 white - 3283 (for HU130, HU132)
HU025
203 €

Basic equipment ● / options ○		Colour	Order No	Price in €	Price in €	Price in €
Cover	SG1 - Era, Manhattan	See fabric chart		1527	1717	1781
	SG2 - Lucia, King, Royal, Medley, Amalfi, Fabric provided, Jgt		1571	1762	1825	
	SG3 - Fame, Field, Climatex Ultra, Chili, Patino, Fernix		1644	1833	1898	
	HP4 - Synergy, PUX, Rime, Steelcut Trio 3		1725	1916	1980	
	LG7 - Semi-Aniline leather		2009	2202	2264	
	Seat shell		Zaha black (techn. fabric) ²	●	●	●
Zaha white (techn. fabric) ²		○	○	○		
Frame	Three-legged	Aluminium	black	2217	●	—
		white	2283	○	—	
Base/ frame	Four-legged	Wood	oak	559	—	●
		Aluminium	black	563217	—	●
	Aluminium	white	563283	—	○	
		polished	563304	—	120 ○	
Inlay	Plastic	black	7217	●	—	
		white	7283	○	—	
	Upholstered	see note ¹	7..	57 ○	—	
Glides	Hard glides for soft floors	black	820	●	●	●
	Felt glides for hard floors	black	821	○	○	○

Remarks:

1 Inlay cover matches seat cover.

2 Seat shell, black:
order-no. ZH01
Seat shell, white:
order-no. ZH07.

3 Packaging optimised for dispatch.

Order example: standard version with various optional extras

Minimum order information		Options (O)			
HU130	/ 5800	- ZH01	/ 2217	/ 7217	/ 821
Basic model	Inner seat shell	Outer seat shell	Colour finish/ Metal parts	Inlay	Castors/ Glides

Recommended price in € exclusive of VAT

HUB 2 & 3 Sofas ³

Standard:

- Inner seat shell upholstered
- Outer seat shell in Zaha (functional fabric)
- Legs in stable diecast aluminium, powder coated

			
HUB 2 low, two-seater sofa low	HUB 3 low, three-seater sofa low	HUB 2 high, two-seater sofa high	HUB 3 high, three-seater sofa high
HU210	HU310	HU212	HU312
Seat mm H: 370 W: 1020 D: 510 W(Ax) 1445 D: 720 Backrest H: 285	Total mm H: 675 W: 1580 D: 510 W(Ax) 2000 D: 720 Backrest H: 285	Seat mm H: 370 W: 1020 D: 510 W(Ax) 1445 D: 720 Backrest H: 435	Total mm H: 820 W: 1580 D: 510 W(Ax) 2000 D: 720 Backrest H: 435
Fabric needed (W:140 cm) Fabric:1,80 rm Leather needed:3,40 m ²	Fabric needed (W:140 cm) Fabric:2,85 rm Leather needed:4,90 m ²	Fabric needed (W:140 cm) Fabric:2,30 rm Leather needed:4,40 m ²	Fabric needed (W:140 cm) Fabric:3,45 rm Leather needed:6,40 m ²

Double socket cable length 1,90 m black - 3217 white - 3283
HU025
203 €

Basic equipment ● / options ○		Colour	Order No	Price in €	Price in €	Price in €	Price in €
Cover	SG1 - Era, Manhattan	See fabric chart		2417	3308	2569	3536
	SG2 - Lucia, King, Royal, Medley, Amalfi, Fabric provided, Jot		2506	3440	2658	3671	
	SG3 - Fame, Field, Climatex Ultra, Chili, Patino, Fernix		2651	3657	2803	3887	
	HP4 - Synergy, PUX, Rime, Steelcut Trio 3		2814	3903	2966	4130	
	LG7 - Semi-Aniline leather		3384	4758	3536	4987	
Seat shell	Zaha black (techn. fabric) ²		●	●	●	●	●
	Zaha white (techn. fabric) ²		○	○	○	○	○
Frame	Aluminium	black	2217	●	●	●	●
		white	2283	○	○	○	○
Inlay	Plastic	black	7217	●	●	●	●
		white	7283	○	○	○	○
Glides	Upholstered	see note ¹	7..	76 ○	76 ○	76 ○	76 ○
		Hard glides for soft floors	black	820	●	●	●
	Felt glides for hard floors	black	821	○	○	○	○

Remarks:

1 Inlay cover matches seat cover.

2 Seat shell, black:
order-no. ZH01
Seat shell, white:
order-no. ZH07.

3 Packaging optimised for dispatch.

Order example: standard version with various optional extras





Minimum order information				Options (O)						
HU310	/	5824	-	ZH01	/	2217	/	75824	/	821
Basic model		Inner seat shell		Outer seat shell		Colour finish/ Metal parts		Inlay		Castors/ Glides

Recommended price in € exclusive of VAT

HUB 2 bench & HUB 3 bench Benches 2

Standard:

- Upper seat shell upholstered
- Lower seat shell in Zaha (functional fabric)
- Legs in stable diecast aluminium, powder coated

					
HU230	HU330	HU23L	HU33L	HU33M	
Seat mm H: 365 W: 575 D: 575	Total mm H: 365 W: 1150 D: 575	Seat mm H: 365 W: 575 D: 575	Total mm H: 365 W: 1730 D: 575	Seat mm H: 365 W: 575 D: 575	
Fabric needed (W:140 cm) Fabric:1,50 rm Leather needed:2,10 m²		Fabric needed (W:140 cm) Fabric:2,25 rm Leather needed:3,15 m²		Fabric needed (W:140 cm) Fabric:0,75 rm Leather needed:1,05 m²	

Double socket cable length 1,90 m black - 3217 white - 3283
HU025
203 €

Basic equipment ● / options ○		Colour	Order No	Price in €	Price in €	Price in €	Price in €	Price in €
Cover	SG1 - Era, Manhattan	See fabric chart		1464	1717	1464	1717	1717
	SG2 - Lucia, King, Royal, Medley, Amalfi, Fabric provided, Jot		1509	1786	1487	1763	1763	
	SG3 - Fame, Field, Climatex Ultra, Chili, Patino, Fernix		1580	1893	1521	1833	1833	
	HP4 - Synergy, PUX, Rime, Steelcut Trio 3		1661	2016	1562	1916	1916	
	LG7 - Semi-Aniline leather		1946	2442	1705	2202	2202	
	Seat shell		Zaha black (techn. fabric) 1	●	●	●	●	●
Zaha white (techn. fabric) 1		○	○	○	○	○	○	
Frame	Aluminium	black	2217	●	●	●	●	
		white	2283	○	○	○	○	
Table top	Melamine, direct faced board (MFC), decorative plastic with ABS-edge in same colour as table top	black	42D	-	-	●	●	
		premium white	42A	-	-	○	○	
		oak	42G	-	-	○	○	
Glides	Hard glides for soft floors	black	820	●	●	●	●	
		Felt glides for hard floors	black	821	○	○	○	○

Remarks:

1 Seat shell, black:
order-no. ZH01
Seat shell, white:
order-no. ZH07.

2 Packaging optimised for dispatch.

Order example: standard version with various optional extras

Minimum order information			Options (O)		
HU230	MH25	ZH07	2283	820	
Basic model	Inner seat shell	Outer seat shell	Colour finish/ Metal parts	Castors/ Glides	

Recommended price in € exclusive of VAT

HUB pouf
Stool

Standard:

- Seat upholstered
- Brown leather hand strap
- Frame in Zaha (tech. Fabric)
- Assembled in box



HUB pouf,
stool

HU037

Total mm
H: 415
W: 360
D: 360

Weight: 2,5 kg

Fabric needed (W:140 cm)
Fabric: 0,9 m
Leather needed: 0,30 m²

Basic equipment ● / options ○		Colour	Order No	Price in €
Cover	SG1 - Era, Manhattan	See fabric chart		254
	SG2 - Lucia, King, Royal, Medley, Amalfi, Fabric provided, Jot			261
	SG3 - Fame, Field, Climatex Ultra, Chili, Patino, Fernix			281
	HP4 - Synergy, PUX, Rime, Steelcut Trio 3			311
	LG7 - Semi-Aniline leather			381
Seat shell	Zaha white (techn. fabric)		○	
	Zaha black (techn. fabric)		●	

Remarks:

- 1 Seat shell, black:
order-no. ZH01
- Seat shell, white:
order-no. ZH07.

Order example: standard version with various optional extras

Minimum order information

HU037 / **MH01** - **ZH07**
Basic model Inner seat shell Outer seat shell

HUB corner
Corner sofa ³

Standard:

- Inner seat shell upholstered
- Outer seat shell in Zaha (functional fabric)
- Legs in stable diecast aluminium, powder coated

			
HUB corner low, corner sofa low	HUB corner high, corner sofa high		
HU320	HU322		
Seat mm H: 370 W: 1540 D: 510	Total mm H: 675	Seat mm H: 370 W: 1540 D: 510	Total mm H: 820
W(Ar) 2005 D: 2005		W(Ar) 2005 D: 2005	
Backrest H: 285		Backrest H: 435	
Fabric needed (W:140 cm) Fabric:5,10 m Leather needed:8,70 m ²		Fabric needed (W:140 cm) Fabric:6,10 m Leather needed:11,3 m ²	

Double socket cable length 1,90 m black - 3217 white - 3283
HU025
203 €

Basic equipment ● / options O		Colour	Order No	Price in €	Price in €
Cover	SG1 - Era, Manhattan	See fabric chart		5088	5470
	SG2 - Lucia, King, Royal, Medley, Amalfi, Fabric provided, Jot			5311	5692
	SG3 - Fame, Field, Climatex Ultra, Chili, Patino, Fernix			5673	6277
	HP4 - Synergy, PUX, Rime, Steelcut Trio 3			6080	7269
	LG7 - Semi-Aniline leather			7505	9686
Seat shell	Zaha black (techn. fabric) ²		●	●	
	Zaha white (techn. fabric) ²		○	○	
Frame	Aluminium	black	2217	●	●
		white	2283	○	○
Inlay	Plastic	black	7217	●	●
		white	7283	○	○
	Upholstered	see note ¹	7..	115 ○	115 ○
Glides	Hard glides for soft floors	black	820	●	●
		Felt glides for hard floors	black	821	○

Remarks:

1 Inlay cover matches seat cover.

2 Seat shell, black:
order-no. ZH01
Seat shell, white:
order-no. ZH07.

3 Packaging optimised for dispatch.

Order example: standard version with various optional extras





Minimum order information				Options (O)																									
H	U	3	2	2	/	5	8	0	0	-	Z	H	0	1	/	2	2	1	7	/	7	5	8	0	0	/	8	2	0
Basic model				Inner seat shell	Outer seat shell	Colour finish/ Metal parts				Inlay	Castors/ Glides																		

Recommended price in € exclusive of VAT

HUB screen
Screen modules ¹

Standard:

- Upholstered on both sides
- Usable as a pin board
- Fitted out with integrated 50 mm polyester absorber plates for optimal sound absorption and shielding

			
HUB screen low, partition wall low	HUB screen high, partition wall high	HUB screen low, partition wall low with decorative stitching on one side	HUB screen high, partition wall high with decorative stitching on one side
HU150	HU152	HU153	HU155
Total mm H: 1350 W: 1000 D: 425	Total mm H: 1900 W: 1000 D: 425	Total mm H: 1350 W: 1000 D: 425	Total mm H: 1900 W: 1000 D: 425
Fabric needed (W:140 cm) Fabric:2,70 rm	Fabric needed (W:140 cm) Fabric:3,80 rm	Fabric needed (W:140 cm) Fabric:2,70 rm	Fabric needed (W:140 cm) Fabric:3,80 rm
Price in €	Price in €	Price in €	Price in €
1514	1642	1564	1692
1581	1731	1631	1781
1689	1875	1739	1924
1811	2037	1863	2089
●	●	●	●
○	○	○	○

Basic equipment ●/options ○		Colour	Order No	Price in €	Price in €	Price in €	Price in €
Cover	SG1 - Era, Manhattan	See fabric chart	2217	●	●	●	●
	SG2 - Lucia, Royal, Medley, Jet			○	○	○	○
	SG3 - Fame, Field, Chili, Patina			○	○	○	○
	HP4 - Synergy, Rime, Steelcut Trio 3			○	○	○	○
Colour finish, metal parts	Steel base & frame in aluminium	black	2217	●	●	●	●
		white	2283	○	○	○	○



Functional hooks
black - 2217
white - 2283

HU027

46 €



Whiteboard &
2 functional hooks
black - 2217
white - 2283

HU028

242 €



Connectors
(2 pieces)
black - 3217
white - 3283

HU026

19 €

Remarks:
1 Packaging optimised for dispatch.



Order example: standard version with various optional extras

Minimum order information			Options (O)		
H	U	150	/	E	R01
Basic model			Colour finish/ Metal parts		
			/ 2217		

HUB board
Mobile walls 2

Standard:

- Upholstered on both sides
- Brown leather hand strap
- Legs in stable diecast aluminium, powder coated
- Securable double castors in same colour as base

	
HUB board, mobile board high	HUB board, mobile wall high with decorative stitching on one side
HUW62	HUW65
Total mm H: 1900 W: 1100 D: 520	Total mm H: 1900 W: 1100 D: 520
Fabric needed (W:140 cm) Fabric:3,80 rm	Fabric needed (W:140 cm) Fabric:3,80 rm

Basic equipment ●/options O		Colour	Order No	Price in €	Price in €
Cover	SG1 - Era, Manhattan	See fabric chart		1514	1564
	SG2 - Lucia, Royal, Medley, Jet			1604	1653
	SG3 - Fame, Field, Chili, Patina			1747	1798
	HP4 - Synergy, Rime, Steelcut Trio 3			1911	1962
Colour finish, metal parts	Legs & frame made of aluminium	black	2217	●	●
		white	2283	○	○
Inlay	Plastic	black	7217	●	●
		white	7283	○	○
	Upholstered	see note ¹	7..	76 ○	76 ○

- Remarks:
- 1 Inlay cover matches wallcover.
 - 2 Packaging optimised for dispatch.

Order example: standard version with various optional extras

Minimum order information				Options (O)			
H	U	W	62	/	F	A	01
Basic model				/	2283		/
				/	7283		
					Colour finish/ Metal parts		Inlay

HUB

HUB

Functional hooks black - 2217 white - 2283
HU027
46 €





Whiteboard & 2 functional hooks black - 2217 white - 2283
HU028
242 €

Recommended price in € exclusive of VAT

HUB board media ²
Mobile media walls ³

Standard:

- Upholstered on both sides
- Universal monitor mount, recommended for TV screens up to 46 inches
- Legs in stable diecast aluminium, powder coated
- Power- and data connection (front) (Schuko, HDMI & USB); 5- fold socket integrated in cable channel
- Formfleece cable channel in anthracite with vertical opening above a zipper, suitable for storing mini PCs and players
- Securable double castors in same colour as base

			
HUB media board low, mobile media board low	HUB media board high, mobile media board high	HUB media board low, mobile media board low with decorative stitching on one side	HUB media board high, mobile media board high decorative stitching on one side
HUM60	HUM62	HUM63	HUM65
Total mm H: 1500 W: 1100 D: 520	Total mm H: 1900 W: 1100 D: 520	Total mm H: 1500 W: 1100 D: 520	Total mm H: 1900 W: 1100 D: 520
Fabric needed (W:140 cm) Fabric:3,00 rm	Fabric needed (W:140 cm) Fabric:3,80 rm	Fabric needed (W:140 cm) Fabric:3,00 rm	Fabric needed (W:140 cm) Fabric:3,80 rm

Basic equipment ●/options O		Colour	Order No	Price in €	Price in €	Price in €	Price in €
Cover	SG1 - Era, Manhattan	See fabric chart		2163	2405	2212	2455
	SG2 - Lucia, Royal, Medley, Jet			2230	2493	2280	2545
	SG3 - Fame, Field, Chili, Patina			2339	2638	2389	2688
	HP4 - Synergy, Rime, Steelcut Trio 3			2461	2800	2510	2851
Colour finish, metal parts	Legs & frame made of aluminium	black	2217	●	●	●	●
		white	2283	○	○	○	○
Inlay	Plastic	black	7217	●	●	●	●
		white	7283	○	○	○	○
	Upholstered	see note ¹	7..	76 ○	76 ○	76 ○	76 ○

Remarks:

- 1 Inlay cover matches wallcover.
- 2 TV screen not included in delivery.
- 3 Packaging optimised for dispatch.





Order example: standard version with various optional extras

Minimum order information				Options (O)			
HUM62	/	ER04	/	2217	/	7ER04	
Basic model		Fabric		Colour finish/ Metal parts		Inlay	

HUB 1 screen ²
Backwalls for HUB 1

Standard:

- Upholstered on both sides
- Glides with leveling up to 10 mm
- Acoustically effective

			
HUB 1 screen low, backwall low suitable for HUB 1	HUB 1 screen high, backwall high suitable for HUB 1	HUB 1 screen low, partition wall low suitable for HUB 1 decorative stitching on one side	HUB 1 screen high, partition wall high suitable for HUB 1 decorative stitching on one side
HU190	HU192	HU193	HU195
Total mm H: 1350 W: 1125 D: 850	Total mm H: 1900 W: 1125 D: 850	Total mm H: 1350 W: 1125 D: 850	Total mm H: 1900 W: 1125 D: 850
Fabric needed (W:140 cm) Fabric:7,00 rm	Fabric needed (W:140 cm) Fabric:9,75 rm	Fabric needed (W:140 cm) Fabric:7,00 rm	Fabric needed (W:140 cm) Fabric:9,75 rm

Functional hooks black - 2217 white - 2283
HU027
46 €

Basic equipment ●/options O		Colour	Order No	Price in €	Price in €	Price in €	Price in €
Cover	SG1 - Era, Manhattan	See fabric chart		2391	2824	2488	2919
	SG2 - Lucia, Royal, Medley, Jet			2547	3024	2641	3120
	SG3 - Fame, Field, Chili, Patina			2800	3350	2895	3445
	HP4 - Synergy, Rime, Steelcut Trio 3			3086	3717	3181	3813
Colour finish, metal parts & technology	Frame	black	22170	●	●	●	●
		white	22830	○	○	○	○
	Acoustic absorber panels & frame ¹	black	22171	344 ○	420 ○	344 ○	420 ○
		white	22831	344 ○	420 ○	344 ○	420 ○

Remarks:

- 1 Fitted out with integrated 50 mm polyester absorber plates for optimal sound absorption and shielding.
- 2 Packaging optimised for dispatch.

Order example: standard version with various optional extras









Minimum order information			Options (O)		
H	U	1	9	2	
Basic model		/	E	R	0
Fabric		/	2	2	1
			7	1	
			Colour finish/ Metal parts		

Recommended price in € exclusive of VAT

HUB 2 screen & HUB 3 screen ³
Backwalls for HUB 2 & HUB 3

Standard:

- Upholstered on both sides
- Glides with leveling up to 10 mm
- Acoustically effective

							
HU240	HU340	HU242	HU342	HU243	HU343	HU245	HU345
Total mm H: 1350 W: 1625 D: 850	Total mm H: 1350 W: 2305 D: 850	Total mm H: 1900 W: 1625 D: 850	Total mm H: 1900 W: 2305 D: 850	Total mm H: 1350 W: 1625 D: 850	Total mm H: 1350 W: 2305 D: 850	Total mm H: 1900 W: 1625 D: 850	Total mm H: 1900 W: 2305 D: 850
Fabric needed (W:140 cm) Fabric:8,40 rm	Fabric needed (W:140 cm) Fabric:8,40 rm	Fabric needed (W:140 cm) Fabric:11,70 rm	Fabric needed (W:140 cm) Fabric:11,70 rm	Fabric needed (W:140 cm) Fabric:8,40 rm	Fabric needed (W:140 cm) Fabric:8,40 rm	Fabric needed (W:140 cm) Fabric:11,70 rm	Fabric needed (W:140 cm) Fabric:11,70 rm
Price in €	Price in €	Price in €	Price in €	Price in €	Price in €	Price in €	Price in €
2658	2925	3091	3358	2818	3085	3314	3581
3647	2985	3253	3647	2985	3253	3603	3869
4118	3313	3580	4118	3313	3580	4075	4341
4648	3679	3945	4648	3679	3945	4604	4872
●	●	●	●	●	●	●	●
○	○	○	○	○	○	○	○
497 ○	382 ○	420 ○	497 ○	382 ○	420 ○	458 ○	497 ○
497 ○	382 ○	420 ○	497 ○	382 ○	420 ○	458 ○	497 ○
1653 ○	1527 ○	1590 ○	1653 ○	1527 ○	1590 ○	1590 ○	1653 ○
1653 ○	1527 ○	1590 ○	1653 ○	1527 ○	1590 ○	1590 ○	1653 ○

Basic equipment ●/options ○		Colour	Order No	Price in €	Price in €	Price in €
Cover	SG1 - Era, Manhattan	See fabric chart	22170	●	●	●
	SG2 - Lucia, Royal, Medley, Jet			○	○	○
	SG3 - Fame, Field, Chili, Patina			○	○	○
	HP4 - Synergy, Rime, Steelcut Trio 3			○	○	○
Colour finish, metal parts & technology	Frame	black	22170	●	●	●
		white	22830	○	○	○
	Acoustic absorber panels & frame ¹	black	22171	382 ○	420 ○	458 ○
		white	22831	382 ○	420 ○	458 ○
	Ambient Light & Frame (transformer required) ²	black	22172	1527 ○	1590 ○	1590 ○
		white	22832	1527 ○	1590 ○	1590 ○

Functional hooks black - 2217 white - 2283
HU027
46 €

Transformer for Ambient light incl. cable bucket for HUB 2 & HUB 3
HU029
255 €

Remarks:

- 1 Fitted out with integrated 50 mm polyester absorber plates for optimal sound absorption and shielding.
- 2 Fitted LED lighting along the inner aluminium frame, adjustable in warmth and intensity of light with included remote control or via app.
- 3 Packaging optimised for dispatch.

Order example: standard version with various optional extras

Minimum order information				Options (O)											
H	U	3	4	0	/	Y	S	0	1	/	2	2	1	7	1
Basic model				Fabric				Colour finish/ Metal parts							

HUB 2 desk & HUB 3 desk
Table 2

Standard:

- Legs in stable diecast aluminium, powder coated
- Glides with leveling up to 10 mm



HUB 2 desk,
table

HUB 3 desk,
table

HU042	HU043
Total mm H: 725 W: 1470 D: 710	Total mm H: 725 W: 2040 D: 710

Basic equipment ●/options ○		Colour	Order No	Price in €	Price in €
Basic price	Basic equipment			887	1016
Frame	Aluminium	black	2217	●	●
		white	2283	○	○
Table top	Melamine, direct faced board (MFC), decorative plastic with ABS-edge in same colour as table top	black	42D	●	●
		premium white	42A	○	○
		oak	42G	○	○
		integrated electrification with sliding cover ¹	..E	246 ○	246 ○
Inlay for table leg	Plastic	black	7217	●	●
		white	7283	○	○

Remarks:

- 1 Shockproof power socket with USB port and cover.
- 2 Packaging optimised for dispatch.

Order example: standard version with various optional extras





Minimum order information/Options (O)

H	U	0	4	2	/	2	2	1	7	/	4	2	G	E	/	7	2	1	7	
Basic model						Colour finish/ Metal parts						Decor					Inlay			

HUB 1 pod
Conference modul

Standard:

- Enclosed conference module with one-sided opening
- Glides with leveling up to 10 mm

			
HUB 1 pod low, one-seater conference pod low	HUB 1 pod high, one-seater conference pod high	HUB 1 pod low, one-seater conference pod low with decorative stitching	HUB 1 pod high, one-seater conference pod high with decorative stitching
HU170	HU172	HU173	HU175
Total mm H: 1350 W: 2480 D: 1125	Total mm H: 1900 W: 2480 D: 1125	Total mm H: 1350 W: 2480 D: 1125	Total mm H: 1900 W: 2480 D: 1125
Fabric needed (W:140 cm) Fabric:15,40 mm	Fabric needed (W:140 cm) Fabric:21,45 mm	Fabric needed (W:140 cm) Fabric:15,40 mm	Fabric needed (W:140 cm) Fabric:21,45 mm

Functional hooks black - 2217 white - 2283
HU027
46 €

Transformer for Ambient light incl. cable bucket for HUB 2 & HUB 3
HU029
255 €

Basic equipment ●/options O		Colour	Order No	Price in €	Price in €	Price in €	Price in €
Cover	5	See fabric chart	SG1 - Era, Manhattan	5355	5736	5929	6373
	SG2 - Lucia, Royal, Medley, Jet		5666	6048	6237	6683	
	SG3 - Fame, Field, Chili, Patina		6176	6556	6747	7193	
	HP4 - Synergy, Rime, Steelcut Trio 3		6745	7126	7318	7762	
Colour finish, metal parts & technology	Frame	black	22170	●	●	●	●
		white	22830	○	○	○	○
	Acoustic absorber panels & frame	black	22171	686 ○	840 ○	686 ○	840 ○
		white	22831	686 ○	840 ○	686 ○	840 ○
Preparation for screen assembly	3	black	..W	508 ○	508 ○	508 ○	508 ○
Table	Without table	-	4000	●	●	●	●
	Melamine, direct faced board (MFC), decorative plastic with ABS-edge in same colour as table top	black	42D	701 ○	701 ○	701 ○	701 ○
		premium white	42A	701 ○	701 ○	701 ○	701 ○
		oak	42G	701 ○	701 ○	701 ○	701 ○
	Integrated electrification with sliding cover	4	white	..E	318 ○	318 ○	318 ○
Inlay for table leg	Plastic	black	7217	●	●	●	●
		white	7283	○	○	○	○
	Upholstered	1	see note	7..	19 ○	19 ○	19 ○

Remarks:

- 1 Inlay cover matches wallcover.
- 2 Fitted out with integrated 50 mm polyester absorber plates for optimal sound absorption and shielding.
- 3 Universal monitor mount, (mounted) recommended for screens up to 40". Wall-integrated cable duct from the monitor mount to under the table.
- 4 Integrated outlet with sliding cover incl. safety socket.

HDMI and USB charging port, white.

5 Packaging optimised for dispatch.

Order example: standard version with various optional extras



Minimum order information				Options (O)																					
H	U	1	7	5	/	5	8	2	4	/	2	2	1	7	1	/	4	2	G	E	/	7	2	1	7
Basic model				Fabric	Colour finish/ Metal parts	Decor		Inlay																	





Recommended price in € exclusive of VAT

HUB 2 pod & HUB 3 pod
Conference modul

Standard:

- Enclosed conference module with one-sided opening
- Glides with leveling up to 10 mm

		
HUB 2 pod low, two-seater conference pod low	HUB 3 pod low, three-seater conference pod low	HUB 2 pod high, two-seater conference pod high
HU270	HU370	HU272
Total mm H: 1350 W: 2480 D: 1625	Total mm H: 1350 W: 2480 D: 2305	Total mm H: 1900 W: 2480 D: 1625
Fabric needed (W:140 cm) Fabric:18,9 cm	Fabric needed (W:140 cm) Fabric:18,9 cm	Fabric needed (W:180 cm) Fabric:26,6 cm

				
HUB 3 pod high, three-seater conference pod high	HUB 2 pod low, two-seater conference pod low with decorative stitching	HUB 3 pod low, three-seater conference pod low with decorative stitching	HUB 2 pod high, two-seater conference pod high with decorative stitching	HUB 3 pod high, three-seater conference pod high with decorative stitching
HU372	HU273	HU373	HU275	HU375
Total mm H: 1900 W: 2480 D: 2305	Total mm H: 1350 W: 2480 D: 1625	Total mm H: 1350 W: 2480 D: 2305	Total mm H: 1900 W: 2480 D: 1625	Total mm H: 1900 W: 2480 D: 2305
Fabric needed (W:140 cm) Fabric:26,6 cm	Fabric needed (W:140 cm) Fabric:18,9 cm	Fabric needed (W:140 cm) Fabric:18,9 cm	Fabric needed (W:140 cm) Fabric:26,6 cm	Fabric needed (W:140 cm) Fabric:26,6 cm

Functional hooks black - 2217 white - 2283
HU027
46 €

Transformer for Ambient light incl. cable bucket for HUB 2 & HUB 3
HU029
255 €

Basic equipment ●/options ○		Colour	Order No	Price in €	Price in €	Price in €	
Cover	6	See fabric chart	SG1 - Era, Manhattan	5889	6462	6272	
	SG2 - Lucia, Royal, Medley, Jet		6289	6861	6669		
	SG3 - Fame, Field, Chili, Patina		6943	7515	7324		
	HP4 - Synergy, Rime, Steelcut Trio 3		7676	8248	8057		
Colour finish, metal parts & technology	Frame	black	22170	●	●	●	
		white	22830	○	○	○	
	Acoustic absorber panels & frame	2	black	22171	763 ○	840 ○	917 ○
		white	22831	763 ○	840 ○	917 ○	
	Ambient Light & Frame (transformer required)	3	black	22172	2227 ○	2353 ○	2353 ○
		white	22832	2227 ○	2353 ○	2353 ○	
Preparation for screen assembly	4	black	..W	508 ○	508 ○	508 ○	
Table	Without table	-	4000	●	●	●	
	Melamine, direct faced board (MFC), decorative plastic with ABS-edge in same colour as table top	black	42D	828 ○	954 ○	828 ○	
		premium white	42A	828 ○	954 ○	828 ○	
		oak	42G	828 ○	954 ○	828 ○	
	Integrated electrification with sliding cover	5	white	..E	318 ○	318 ○	318 ○
Inlay for table leg	Plastic	black	7217	●	●	●	
		white	7283	○	○	○	
	Upholstered	see note 1	7..	19 ○	19 ○	19 ○	

Price in €	Price in €	Price in €	Price in €	Price in €
6907	6207	6907	6589	7352
7306	6608	7306	6990	7752
7961	7261	7961	7642	8405
8694	7994	8694	8375	9140
●	●	●	●	●
○	○	○	○	○
992 ○	763 ○	840 ○	917 ○	992 ○
992 ○	763 ○	840 ○	917 ○	992 ○
2481 ○	2227 ○	2353 ○	2353 ○	2481 ○
2481 ○	2227 ○	2353 ○	2353 ○	2481 ○
508 ○	508 ○	508 ○	508 ○	508 ○
●	●	●	●	●
954 ○	828 ○	954 ○	828 ○	954 ○
954 ○	828 ○	954 ○	828 ○	954 ○
954 ○	828 ○	954 ○	828 ○	954 ○
954 ○	828 ○	954 ○	828 ○	954 ○
318 ○	318 ○	318 ○	318 ○	318 ○
●	●	●	●	●
○	○	○	○	○
19 ○	19 ○	19 ○	19 ○	19 ○

Remarks:

- 1 Inlay cover matches wallcover.
- 2 Fitted out with integrated 50 mm polyester absorber plates for optimal sound absorption and shielding.
- 3 Fitted LED lighting along the inner aluminium frame, adjustable in warmth and intensity of light with included remote control or via app.
- 4 Universal monitor mount, (mounted) recommended for

screens up to 40". Wall-integrated cable duct from the monitor mount to under the table.

5 Integrated outlet with sliding cover incl. safety socket, HDMI and USB charging port, white.

6 Packaging optimised for dispatch.



Order example: standard version with various optional extras

Minimum order information		Options (O)	
HU272	YS02	22172	42G / 7217
Basic model	Fabric	Colour finish/ Metal parts	Decor Inlay

HUB booth
Phone booths with table ¹

Standard:

- Upholstered on both sides
- Suspended table in DBS, white
- Fitted out with integrated 50 mm polyester absorber plates for optimal sound absorption and shielding

	
HUB booth, phone booth high	HUB booth, phone booth high with decorative stitching on outside
HU182	HU185
Total mm H: 1900 W: 1275 D: 1260	Total mm H: 1900 W: 1275 D: 1260

Functional hooks black - 2217 white - 2283
HU027
46 €

Basic equipment ●/options O		Colour	Order No	Price in €	Price in €
Cover	SG1 - Era, Manhattan	See fabric chart		4961	5120
	SG2 - Lucia, Royal, Medley, Jet			5251	5409
	SG3 - Fame, Field, Chili, Patina			5721	5881
	HP4 - Synergy, Rime, Steelcut Trio 3			6251	6409
Colour finish, metal parts	Frame	black	2217	●	●
		white	2283	○	○

Remarks:
1 Packaging optimised for dispatch.

Order example: standard version with various optional extras

Minimum order information			Options (O)		
HU182	/	ER01	/	2217	
Basic model		Fabric		Colour finish/ Metal parts	

Recommended price in € exclusive of VAT

HUB 3 swing
Sofa with swing base ²



Standard:

- Inner seat shell upholstered
- Outer seat shell in Zaha (functional fabric)
- Stable steel base powder- coated
- Heavy duty carrying strap
- Plastic glides, black

HUB 3 swing,
three-seater sofa
with swing base
low

HU380

Seat mm	Total mm
H: 470	H: 1950
W: 1880	
D: 510	W(A): 2600
Backrest	D: 1595
	H: 285

Fabric needed (W:140 cm)
Fabric:5,10 m
Leather needed:8,70 m²

Basic equipment ● / options O		Colour	Order No	Price in €
Cover	SG1 - Era, Manhattan	See fabric chart		11322
	SG2 - Lucia, King, Royal, Medley, Amalfi, Fabric provided, Jot			11454
	SG3 - Fame, Field, Climatex Ultra, Chili, Patino, Fernix			11671
	HP4 - Synergy, PUX, Rime, Steelcut Trio 3			11916
	LG7 - Semi-Aniline leather			12771
Seat shell	Zaha black (techn. fabric) ¹			●
	Zaha white (techn. fabric) ¹			○
Frame	Steel	black	2217	●
		white	2283	○

Remarks:

1 Seat shell, black:
order-no. ZH01
Seat shell, white:
order-no. ZH07.

2 Packaging optimised for dispatch.

Order example: standard version with various optional extras

Minimum order information			Options (O)		
HU380	/ SA01	- ZH01	/	2283	
Basic model	Inner seat shell	Outer seat shell		Colour finish/ Metal parts	

Recommended price in € exclusive of VAT

HUB pillows
Cushions ¹



Standard:

- Cushions filled with polyester fibre

HUB pillows,
cushion set,
large: 540 x 350 mm (WxH),
small: 440 x 270 mm (WxH)

HU910

Fabric needed (W:140 cm)
Fabric:0,80 m
Leather needed:1,10 m²

Basic equipment ● / options ○	Colour	Order No	Price in €
SG1 - Era, Manhattan	See fabric chart		118
SG2 - Lucia, King, Royal, Medley, Amalfi, Fabric provided, Jot			126
SG3 - Fame, Field, Climatex Ultra, Chili, Patino, Fernix			135
HP4 - Synergy, PUX, Rime, Steelcut Trio 3			143
LG7 - Semi-Aniline leather			203

Remarks:

¹ Packaging optimised for dispatch.

Order example: standard version with various optional extras

Minimum order information

HU910 / ER04
Basic model Fabric

Recommended price in € exclusive of VAT

HUB table 1
Side tables ¹

Standard:

- Table top (MDF), 19 mm
- Brown leather hand strap



HUB table 1,
side table set,
large: 490 x 420 x 420 mm (HxWxD),
small: 410 x 320 x 320 mm (HxWxD)

HU920

Basic equipment ●/options ○		Colour	Order No	Price in €
Basic price	Basic equipment			635
Frame	Tubular steel	black	2217	●
		white	2283	○
Table top	HPL, decor plastic with painted edge, same colour as table top	black	42D	●
		premium white	42A	○
		oak	42G	○

Remarks:

- ¹ Packaging optimised for dispatch.

Order example: standard version with various optional extras

Minimum order information/Options (O)

H	U	9	2	0	/	2	2	1	7	/	4	2	D
Basic model						Colour finish/ Metal parts					Decor		

Recommended price in € exclusive of VAT

HUB table 2
Side tables ¹

Standard:

- Curved steel plate (5 mm)



HUB table 2,
side table set,
large: 600 x 360 x 350 mm (HxWxD),
small: 500 x 320 x 300 mm (HxWxD)

HU930

Basic equipment ●/options ○		Colour	Order No	Price in €
Basic price	Basic equipment			635
Frame	Steel	black	2217	●
		white	2283	○

Remarks:

- ¹ Packaging optimised for dispatch.

Order example: standard version with various optional extras

Minimum order information/Options (O)

H	U	9	3	0	/	2	2	1	7	
Basic model						Colour finish/ Metal parts				

Recommended price in € exclusive of VAT



T530 / T510 / T550



T520



T540

Quality:



Warranty (10 year)



Tested safety (partial)

Environment:



Quality produced for the environment



Tested for contaminants



The Blue Angel
www.blauer-engel.de/uz117

Product design B4K Andreas Krob, Wolfhalden



German Design Award 2016



ICONIC AWARDS 2016:
Interior Innovation



German Brand Award 2016

TANGRAMis5
Seating element,
stool/ table element, cushion

Standard:

- Aluminium metal parts

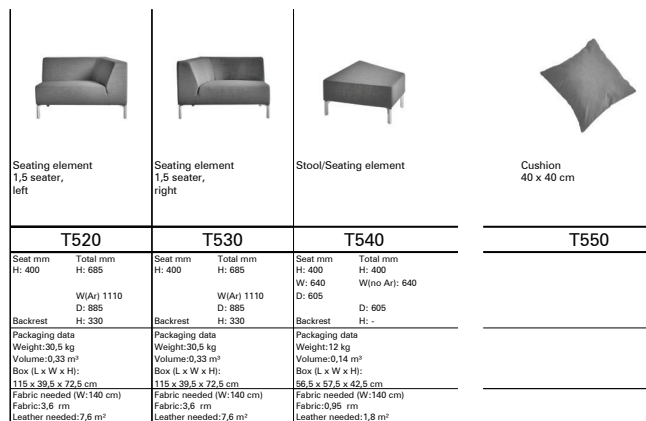

Basic equipment ●/options O		Colour	Order No	Price in €	Price in €	Price in €	Price in €
Cover	SG1 - Citadel, Era	See fabric chart		●	●	●	68
	SG2 - Lucia, King, Medley, Amalfi, Jet			○	○	○	72
	SG3 - Fame, Field, Chili, Patina, Remix			●	●	●	80
	HP4 - Synergy, PUxx, Rime, Steelcut Trio 3			○	○	○	85
	LG7 - Semi-Aniline leather			●	●	●	121
Frame	Aluminium	black	2217	●	●	●	-
		polished	2304	○	○	○	-
Glides ¹	Change glides for hard and soft floors	-	820	●	●	●	-
	Hard double castors	black	802	○	○	○	-
	Soft double castors	black	801	○	○	○	-
Delivery ²	Partly assembled in box	-	902	●	●	●	-

Remarks:

1 You can turn over the glides to match different flooring (hard/ soft).

2 Accessories: Electrification and link element.
Please ask for permanent frame reterdent version.

Order example: standard version with various optional extras

Minimum order information				Options (O)												
T	5	3	0	/	C	1	1	1	/	8	2	0	/	9	0	2
Basic model				Fabric				Castors/ Glides		Delivery						

Recommended price in € exclusive of VAT

TANGRAMis5
Table

Standard:

- Steel frame
- Table top (HPL), 8 mm
- Assembled in box



Table,
trapezoid,
height adjustable

T510

Dimens. mm H: 405-625
W: 640 D: 605

Packaging data
Weight: 11 kg
Volume: 0,14 m³
Box (L x W x H):
56,5 x 57,5 x 42,5cm

Basic equipment ●/options ○		Colour	Order No	Price in €
Basic price	Basic equipment			690
Frame	Steel	black	2217	●
		chromed	2324	○
Table top	HPL	black	42D	●
		premium white	42A	○
Glides	1 Change glides for hard and soft floors	-	820	●

Remarks:

- 1 You can turn over the glides to match different flooring (hard/ soft).
- 2 Straight edge, black.

Order example: standard version with various optional extras

Minimum order information/Options (O)

T510	/	2217	/	42A	/	820
Basic model		Colour finish/ Metal parts		Decor		Castors/ Glides

Recommended price in € exclusive of VAT



LM755



LM741



LM740

Quality:



Warranty (10 year)



Tested safety

Environment:



Quality produced for the environment



Tested for contaminants



The Blue Angel
www.blauer-engel.de/uz117

Product design Interstuhl



Bifma e3
level Platin



Level 3
European Sustainability
Certificate
- highest level

LEMONis5
bistro table ¹

Standard:

- Steel frame



Circular bistro table

LM800

Dimens. mm H: 735
D: 800

Packaging data
Weight: 28 kg

Basic equipment ●/options ○		Colour	Order No	Price in €
Basic price	Basic equipment			732
Frame	Steel	black	2217	●
		white	2283	○
		chrome finish ²	2324S	57 ○
Table top	Melamine, direct coated (DBS), plastic laminate	black	41D	●
		premium white	41A	○

Remarks:

¹ Standard packaging: Wrapped in plastic film on palettes.

² Baseplate is black.

Order example: standard version with various optional extras

Minimum order information/Options (O)

L	M	8	0	0	/	2	2	1	7	/	4	1	D
Basic model						Colour finish/ Metal parts					Decor		

Recommended price in € exclusive of VAT

LEMON



LI780



LI780



Quality:



Warranty (10 year)



Tested safety

Environment:



Quality produced for the environment



Tested for contaminants



The Blue Angel
www.blauer-engel.de/uz117

Product design Studiokurbos GmbH, Stuttgart



Bifma e3
level Platin



Level 3
European Sustainability
Certificate
- highest level

LIMEis5
Bar stool

Standard:

- Seat height adjustment ¹
- Felt glides



Bar stool
with footrest

LI780

Seat mm	Total mm
H: 705-840	H: 840
W: 310	W(no Ar): 385
D: 330	
	D: 410
Backrest	H: -

Packaging data	
Weight: 17,3 kg	
Volume: 0,17 m ³	
Box (L x W x H):	
43 x 43 x 93 cm	
Fabric needed (W:140 cm)	
Fabric: 0,75 m ²	
Leather needed: 0,75 m ²	

Basic equipment ● / options ○		Colour	Order No	Price in €
Seat and back cover	SG1 - Era	See fabric chart		702
	SG2 - Lucia, King, Medley, Amalfi, Jet		727	
	SG3 - Fame, Field, Chili, Patina, Remix		753	
	HP4 - Synergy, Rime, Steelcut Trio 3		782	
	LG6 - Nappa leather ²		876	
	LG7 - Semi-Aniline leather ²		917	
Colours	Metal parts	black	2217	●
		brilliant silver	2234	○
		chromed	2324	○
Delivery	Assembled in protective cover	-	904	●
	Assembled in box	-	903	○

Remarks:

- 1 Lever always polished.
- 2 Perforated seat with leather upholstery.

Order example: standard version with various optional extras

Minimum order information				Options (O)														
L	I	7	8	0	/	E	R	0	1	/	2	3	2	4	/	9	0	4
Basic model				Fabric	Colour finish/ Metal parts				Delivery									

Recommended price in € exclusive of VAT

LIMEis5
standing table ¹

Standard:
- Steel frame



Circular standing table

L1800

Dimens. mm H: 1090
D: 800

Packaging data
Weight: 29,5 kg

Basic equipment ●/options ○		Colour	Order No	Price in €
Basic price	Basic equipment			766
Frame	Steel	black	2217	●
		white	2283	○
		chrome finish ²	2324S	57 ○
Table top	Melamine, direct coated (DBS), plastic laminate	black	41D	●
		premium white	41A	○

Remarks:

1 Standard packaging: Wrapped in plastic film on palettes.

2 Baseplate is black.

Order example: standard version with various optional extras

Minimum order information/Options (O)

L1800	/	2217	/	41D
Basic model		Colour finish/ Metal parts		Decor

Recommended price in € exclusive of VAT



710K



700K



736K

Quality:



Warranty (10 year)



Tested safety (partial)



BIFMA 2011 (700K)



Quality produced for the environment

Environment:



Tested for contaminants



The Blue Angel
www.blauer-engel.de/uz117



Bifma e3 level Platin



Level 3 European Sustainability Certificate - highest level



reddot design award 2013



German Design Award 2014 special mention

Product design Phoenix Design, Stuttgart

KINETICis5
Perch, bar stool

Standard:

- Seat height adjustment
- Aluminium metal parts

 Perch ³	 Bar stool ³	 Bar stool with footrest			
700K	705K	710K			
Seat mm H: 665-815 W: 490 D: 210	Total mm H: 865 W(no Ar): 535 D: 360	Seat mm H: 735/855 W: 380 D: 400	Total mm H: 735/855 W(no Ar): 630 D: 630	Seat mm H: 735/855 W: 380 D: 400	Total mm H: 735/855 W(no Ar): 630 D: 630
Backrest H: -	Backrest H: -	Backrest H: -	Backrest H: -	Backrest H: -	Backrest H: -
Packaging data Weight: 6,5 kg Volume: 0,09 m ³ Box (L x W x H): 74 x 53 x 22 cm	Packaging data Weight: 9,6 kg Volume: 0,15 m ³ Box (L x W x H): 75 x 42 x 49 cm	Packaging data Weight: 11,5 kg Volume: 0,15 m ³ Box (L x W x H): 75 x 42 x 49 cm	Packaging data Weight: 11,5 kg Volume: 0,15 m ³ Box (L x W x H): 75 x 42 x 49 cm	Packaging data Weight: 11,5 kg Volume: 0,15 m ³ Box (L x W x H): 75 x 42 x 49 cm	Packaging data Weight: 11,5 kg Volume: 0,15 m ³ Box (L x W x H): 75 x 42 x 49 cm
Fabric needed (W:140 cm) Fabric: 0,25 m ² Leather needed: 0,22 m ²	Fabric needed (W:140 cm) Fabric: 0,52 m ² Leather needed: 0,45 m ²	Fabric needed (W:140 cm) Fabric: 0,52 m ² Leather needed: 0,45 m ²	Fabric needed (W:140 cm) Fabric: 0,52 m ² Leather needed: 0,45 m ²	Fabric needed (W:140 cm) Fabric: 0,52 m ² Leather needed: 0,45 m ²	Fabric needed (W:140 cm) Fabric: 0,52 m ² Leather needed: 0,45 m ²

Basic equipment ● / options ○		Colour	Order No	Price in €	Price in €	Price in €
Finishes and colours for seat	HPL / wood ⁴	See fabric chart		-	541	596
	SG2 - Lucia, King, Medley, Amalfi, Jet		481	568	626	
	SG3 - Fame, Chili, Patina, Remix		496	588	644	
	LG7 - Semi-Aniline leather		550	644	702	
	Integral foam ¹		550	626	683	
Colour finish, metal parts	Aluminium	black	2217	●	●	●
		brilliant silver	2234	49 ○	49 ○	49 ○
		white	2283	49 ○	49 ○	49 ○
Surface and ⁴ colours for seat (wood)	HPL	black	42D	-	●	●
		white	42A	-	13 ○	13 ○
	Wood	oak	434	-	19 ○	19 ○
		American walnut	435	-	19 ○	19 ○
Base	Seat height 650 - 770 mm	as metal parts	521H	-	●	●
	Seat height 530 - 650 mm	as metal parts ³	521N	-	○	○
Glides ²	Hard glides for soft floors	-	820	●	●	●
	Soft glides for hard floors	-	821	○	○	○
Delivery	Knocked down in box	-	902	●	●	●
	Assembled in box	-	903	17 ○	17 ○	17 ○

Remarks:

1 For integral foam seat, please choose a colour. Integral foam black (standard); Order no. 2000. Integral foam grey; Order no. 2002.

2 You can turn over the glides to match different flooring (hard/ soft).

3 Model 700K GS (1335) approved as well as Bifma (2011). Model 705K, seat height 530-650mm GS (1335) approved.

4 Please select the type of wood if the seat surface is "Wood"

(not an option for fabric covers, Amalfi, Semi-Aniline leather or integral foam).

Order example: standard version with various optional extras

Minimum order information				Options (O)																						
7	0	5	K	/	5	8	0	0	/	2	2	3	4	/	5	2	1	N	/	8	2	1	/	9	0	3
Basic model				Fabric				Colour finish/ Metal parts				Base				Castors/ Glides				Delivery						

Recommended price in € exclusive of VAT

KINETICis5
Standing table

Standard:

- Aluminium metal parts
- Assembled in protective box
- Table top (MDF), 28 mm
- Edge, ABS (2 mm)
- Four legged

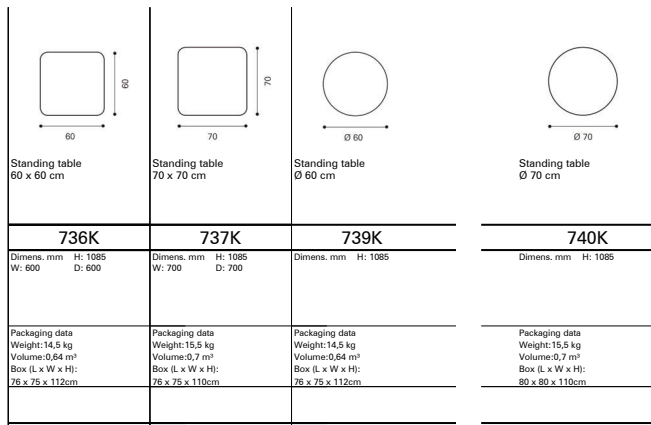

Basic equipment ●/options ○		Colour	Order No	Price in €	Price in €	Price in €	Price in €
Basic price				584	610	584	610
Colour finish, metal parts	Aluminium	black	2217	●	●	●	●
		brilliant silver	2234	49 ○	49 ○	49 ○	49 ○
		white	2283	49 ○	49 ○	49 ○	49 ○
Table top ¹	HPL	black	42D	●	●	●	●
		white	42A	69 ○	92 ○	69 ○	92 ○
	Wood	oak	459	168 ○	229 ○	168 ○	229 ○
		American walnut	455	219 ○	277 ○	219 ○	277 ○
Glides	Hard glides for soft floors	-	820	●	●	●	●
	Soft glides for hard floors	-	821	○	○	○	○

Remarks:

- ¹ The underside of the table top always white for HPL white and oak table top.
- The underside of the table top always black for HPL black and American walnut table top.

Order example: standard version with various optional extras

Minimum order information/Options (O)

7	3	7	K	/	2	2	3	4	/	4	2	A	/	8	2	1
Basic model					Colour finish/ Metal parts					Decor			Castors/ Glides			

Recommended price in € exclusive of VAT



100U



100U



UP

Quality:



Warranty (10 year)



Tested safety



BIFMA compliant

Environment:



Quality produced for the environment



The Blue Angel
www.blauer-engel.de/uz117

Product design ID AID, Sven von Boetticher, Stuttgart



German Design Award
2017 GOLD



Focus Open 2016
Special Mention



iF product design
award 2017

UPis1
Stool 1

Standard:

- Height-adjustable seat by wrist strap
- Soft seat inlay, basalt grey
- Slip-resistant base plate



110U		100U		090U	
Seat mm H: 590 - 845	Total mm H: 845 W: 330	Seat mm H: 450-630	Total mm H: 630 W: 335	Seat mm H: 375-490	Total mm H: 490 W: 330
Packaging data Weight:5,02 kg Volume:0,08 m³ Box (L x W x H): 34,5 x 34 x 85,5 cm		Packaging data Weight:4,3 kg Volume:0,06 m³ Box (L x W x H): 36 x 36 x 49 cm		Packaging data Weight:4,4 kg Volume:0,06 m³ Box (L x W x H): 35 x 35 x 49 cm	

Basic equipment ●/options ○		Colour	Order No	Price in €	Price in €	Price in €
Seat	Soft Inlay			170	158	147
Colour finish	Body, stool	deep grey	3217	●	●	●
		smart white	3403	○	○	○
		fresh yellow	3400	○	○	○
		soft red	3401	○	○	○
		ice blue	3402	○	○	○
		red	3207	○	○	○
Delivery	Assembled in box	-	903	●	●	●

Remarks:

- 1 This product is not suitable for outdoor areas.

Order example: standard version with various optional extras

Minimum order information/Options (O)

1	0	0	U	/	3	4	0	3	/	9	0	3	
Basic model					Colour finish					Delivery			

UP

Recommended price in € exclusive of VAT

UPis1
Cushion 1



Cushion
Ø 320 mm

150U

Packaging data

Volume: 0,005 m³
Box (L x W x H):
34 x 36 x 4cm

Basic equipment ● / options ○		Colour	Order No	Price in €
Seat	SG1 - Era			24
Delivery	Packaged in box	-	903	●

UPis1

UP

Remarks:

1 This product is not suitable for outdoor areas.

Order example: standard version with various optional extras

Minimum order information

150U / ER01
Basic model Fabric

Recommended price in € exclusive of VAT



270B



550B



420B

BUDDY

Quality:



Warranty (10 year)



Tested safety



Quality Office

Environment:



Quality produced for the environment



Tested for contaminants



Bifma e3 level Platin



The Blue Angel
www.blauer-engel.de/uz117

Product design ID AID, Sven von Boetticher, Stuttgart

BUDDYis3
Conference chairs

Standard:

- Mesh backrest
- Seat upholstered
- Rocking motion, lockable
- Seat height adjustment

	
Conference chair with base and castors	Conference chair with armrests, base and castors
220B	270B
Seat mm: Total mm H: 420 - 530 H: 1015 W: 450 W(no Ar): 480 D: 415 D: 540 Backrest H: 515	Seat mm: Total mm H: 420 - 530 H: 1015 W: 450 W(Ar) 610 D: 415 D: 540 Backrest H: 515
Packaging data Weight: 11 kg Volume: 0,5 m³ Box (L x W x H): 73,5 x 71 x 97 cm Fabric needed (W:140 cm) Fabric: 0,6 m Leather needed: 0,7 m²	Packaging data Weight: 11,5 kg Volume: 0,5 m³ Box (L x W x H): 73,5 x 71 x 97 cm Fabric needed (W:140 cm) Fabric: 0,6 m Leather needed: 0,7 m²

Basic equipment ● / options ○		Colour	Order No	Price in €	Price in €
Seat cover	2	SG1 - Citadel, Era, Manhattan	See fabric chart	●	●
		SG2 - Lucia, King, Royal, Medley, Fabric provided, Jet		○	○
		SG3 - Fame, Field, Chili, Patina, Remix		○	○
		LG6 - Nappa leather		○	○
		Mesh design coloured		○	○
Colour finish	1	Plastic parts	black	3217	●
			white	3283	○
Base		Polyamide	as col. finish	532	●
		Aluminium	brilliant silver	521234	○
			polished	521304	○
Castors Ø65/ Glides		Hard double castors	black	802	●
		Soft double castors	black	801	○
		Glides for soft floors	black	811	○
			black	815	○
Delivery		Knocked down in box	-	902	●
		Assembled in protective cover	-	904	○
		Assembled in box	-	903	○

Remarks:

1 **Finish plastic parts:**
All plastic parts except armrests, gas column, castors, cover of the mechanism, lever and glides. These are always black.

2 Meshdesign, black: order-no. 8140.
Meshdesign, white: order-no. 8144.
Meshdesign, coloured:
order-no. 8123, 8113, 8114, 8125, 8148, 8162 & 8172.

Order example: standard version with various optional extras

Minimum order information				Options (O)																													
2	2	0	B	/	M	H	0	1	-	8	1	4	4	/	3	2	8	3	/	5	2	1	3	0	4	/	8	1	1	/	9	0	3
Basic model				Seat cover				Back cover				Colour finish				Base				Castors/ Glides				Delivery									

Recommended price in € exclusive of VAT

BUDDYis3
Visitor chairs

Standard:

- Mesh backrest
- Seat upholstered
- Tubular steel frame

420B	470B	520B	570B
Seat mm H: 470 W: 450 D: 410	Total mm H: 930 W(no Ar): 485 D: 540	Seat mm H: 470 W: 450 D: 410	Total mm H: 930 W(no Ar): 485 D: 540
Backrest H: 515	Backrest H: 515	Backrest H: 515	Backrest H: 515
Packaging data Weight:7 kg Volume:0,4 m³ Box (L x W x H): 65 x 61 x 100 cm	Packaging data Weight:7,5 kg Volume:0,4 m³ Box (L x W x H): 65 x 61 x 100 cm	Packaging data Weight:7,5 kg Volume:0,4 m³ Box (L x W x H): 65 x 61 x 100 cm	Packaging data Weight:8 kg Volume:0,4 m³ Box (L x W x H): 65 x 61 x 100 cm
Fabric needed (W:140 cm) Fabric:0,6 m Leather needed:0,7 m²	Fabric needed (W:140 cm) Fabric:0,6 m Leather needed:0,7 m²	Fabric needed (W:140 cm) Fabric:0,6 m Leather needed:0,7 m²	Fabric needed (W:140 cm) Fabric:0,6 m Leather needed:0,7 m²

Basic equipment ●/options ○		Colour	Order No	Price in €	Price in €	Price in €	Price in €
Seat cover	SG1 - Citadel, Era, Manhattan	See fabric chart		269	329	313	373
	SG2 - Lucia, King, Royal, Medley, Fabric provided, Jet		288	346	332	389	
	SG3 - Fame, Field, Chili, Patina, Remix		316	376	359	418	
	LG6 - Nappa leather		441	497	483	542	
	Mesh design coloured		●	●	●	●	
Frame	Tubular steel	as col. finish	-	●	●	●	●
		brilliant silver	2234	43 ○	43 ○	43 ○	43 ○
		chromed	2324	82 ○	82 ○	82 ○	82 ○
Colour finish, plastic parts	Backrest	black	3217	●	●	●	●
		white	3283	31 ○	31 ○	31 ○	31 ○
Glides	Polypropylene glides for soft floors	black	820	●	●	-	-
	Felt glides for hard floors	black 2	821	19 ○	19 ○	19 ○	19 ○
Delivery	Assembled in protective cover	-	904	●	●	●	●
	Assembled in box	-	903	○	○	○	○

Remarks:

- Stacking can cause indentations for leather versions.
- Felt glides for cantilever, transparent.
- Meshdesign, black: order-no. 8140.
Meshdesign, white: order-no. 8144.
Meshdesign, coloured:
order-no. 8123, 8113, 8114, 8125, 8148, 8162 & 8172.

Order example: standard version with various optional extras

Minimum order information				Options (O)																											
4	2	0	B	/	M	H	0	1	-	8	1	4	4	/	2	3	2	4	/	3	2	8	3	/	8	2	1	/	9	0	3
Basic model				Seat cover				Back cover				Colour finish/ Metal parts				Colour finish				Castors/ Glides				Delivery							

Recommended price in € exclusive of VAT

BUDDYis3
Conference chairs

Standard:

- Backrest Chillback, black
- Seat upholstered
- Rocking motion, lockable
- Seat height adjustment

	
Conference chair with base and castors	Conference chair with armrests, base and castors
210B	260B
Seat mm: H: 420 - 530 W: 450 D: 415 Total mm: H: 1015 W(no Ar): 480 D: 540 Backrest: H: 515 Packaging data: Weight: 11 kg, Volume: 0,5 m³, Box (L x W x H): 73,5 x 71 x 97 cm Fabric needed (W: 140 cm): Fabric: 1,2 m	Seat mm: H: 420 - 530 W: 450 D: 415 Total mm: H: 1015 W: 450 W(Ar): 610 D: 540 Backrest: H: 515 Packaging data: Weight: 11,5 kg, Volume: 0,5 m³, Box (L x W x H): 73,5 x 71 x 97 cm Fabric needed (W: 140 cm): Fabric: 1,2 m

Basic equipment ● / options ○		Colour	Order No	Price in €	Price in €	
1 Seat and back cover	SG1 - Citadel, Ere, Manhattan	See fabric chart		381	436	
	SG2 - Lucia, King, Royal, Medley, Jet		397	453		
	SG3 - Fame, Chili, Patina		428	483		
Colour finish	Plastic parts	2 black	3217	●	●	
		white	3283	31 ○	31 ○	
Base	Polyamide	as col. finish	532	●	●	
		Aluminium	brilliant silver	521234	55 ○	55 ○
			polished	521304	128 ○	128 ○
Castors Ø65/ Glides	Hard double castors	black	802	●	●	
		black	801	○	○	
		black	811	28 ○	28 ○	
		black	815	37 ○	37 ○	
Delivery	Knocked down in box	-	902	●	●	
		-	904	17 ○	17 ○	
		-	903	17 ○	17 ○	

Remarks:

1 Carrier material, backrest (from the back) always black.

2 Finish plastic parts:
All plastic parts except armrests, gas column, castors, cover of the mechanism, lever and glides. These are always black.

Order example: standard version with various optional extras

Minimum order information			Options (O)																									
2	1	0	B	/	M	H	0	1	/	3	2	8	3	/	5	2	1	3	0	4	/	8	1	1	/	9	0	3
Basic model			Fabric	Colour finish	Base	Castors/ Glides		Delivery																				





BUDDY

Recommended price in € exclusive of VAT

BUDDYis3
Visitor chairs

Standard:

- Backrest Chillback, black
- Seat upholstered
- Tubular steel frame

			
Four legs, stacking height: 6 pieces	Four legs, with armrests, stacking height: 6 pieces	Cantilever frame, stacking height: 4 pieces	Cantilever frame, with armrests, stacking height: 4 pieces
400B	450B	500B	550B
Seat mm H: 470 W: 450 D: 410 D: 540 Backrest H: 515	Total mm H: 930 W(no Ar): 485 W(Ar): 595 D: 595 Backrest H: 515	Seat mm H: 470 W: 450 D: 410 D: 540 Backrest H: 515	Total mm H: 930 W(no Ar): 485 W(Ar): 610 D: 540 Backrest H: 515
Packaging data Weight: 7 kg Volume: 0,4 m³ Box (L x W x H): 61 x 65 x 100 cm Fabric needed (W:140 cm) Fabric: 1,2 m	Packaging data Weight: 7,5 kg Volume: 0,4 m³ Box (L x W x H): 65 x 61 x 100 cm Fabric needed (W:140 cm) Fabric: 1,2 m	Packaging data Weight: 7,5 kg Volume: 0,4 m³ Box (L x W x H): 65 x 61 x 100 cm Fabric needed (W:140 cm) Fabric: 1,2 m	Packaging data Weight: 8 kg Volume: 0,4 m³ Box (L x W x H): 65 x 61 x 100 cm Fabric needed (W:140 cm) Fabric: 1,2 m

Basic equipment ●/options ○		Colour	Order No	Price in €	Price in €	Price in €	Price in €
Seat and back cover	1 SG1 - Citadel, Ere, Manhattan	See fabric chart		313	373	357	415
	SG2 - Lucia, King, Royal, Medley, Jet		332	389	377	434	
	SG3 - Fame, Chili, Patina		359	418	404	464	
Frame	Tubular steel	as col. finish	-	●	●	●	●
		brilliant silver	2234	43 ○	43 ○	43 ○	43 ○
		chromed	2324	82 ○	82 ○	82 ○	82 ○
Colour finish, plastic parts	Backrest	black	3217	●	●	●	●
		white	3283	31 ○	31 ○	31 ○	31 ○
Glides	Polypropylene glides for soft floors	black	820	●	●	-	-
	Felt glides for hard floors	black ²	821	19 ○	19 ○	19 ○	19 ○
Delivery	Assembled in protective cover	-	904	●	●	●	●
	Assembled in box	-	903	○	○	○	○

Remarks:

- Carrier material, backrest (from the back) always black.
- Felt glides for cantilever, transparent.

Order example: standard version with various optional extras

Minimum order information				Options (O)																						
4	0	0	B	/	M	H	0	1	/	2	3	2	4	/	3	2	8	3	/	8	2	1	/	9	0	3
Basic model				Fabric	Colour finish/ Metal parts				Colour finish	Castors/ Glides				Delivery												

Recommended price in € exclusive of VAT

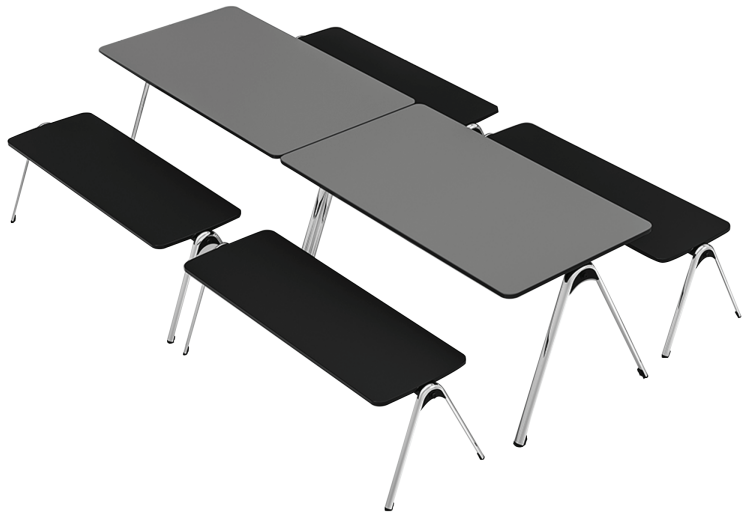

V8016/V115



V101K



V120K

VLEGS

Quality:



Warranty (10 year)



Tested safety



Quality produced for the environment

Environment:



Tested for contaminants



The Blue Angel
www.blauer-engel.de/uz117



Products of outstanding architectural quality



German Design Award
2016 NOMINEE



iF product design award
award 2015









reddot design award
award 2015

Product design Ballendat, Simbach am Inn

VLEGSis3
Visitor chairs

Standard:

- Steel frame, chromed

					
Four legged, not upholstered, plastic shell ² , stacking height: 20 pieces	Four legged, with seat upholstered, plastic shell ² , stacking height: 20 pieces	Four legged, with seat and back upholstered, plastic shell ² , stacking height: 20 pieces	Four legged, not upholstered, wooden shell ² , stacking height: 20 pieces	Four legged, with seat upholstered, wooden shell ² , stacking height: 15 pieces	Four legged, with seat and back upholstered, wooden shell ² , stacking height: 10 pieces
V100K	V101K	V102K	V100H	V101H	V102H
Seat mm: H: 435, Total mm: H: 820, W: 445, W(no Ar): 510, D: 415, D: 565, H: 420	Seat mm: H: 445, Total mm: H: 820, W: 445, W(no Ar): 510, D: 415, W(Ar): 510, D: 565, H: 420	Seat mm: H: 445, Total mm: H: 820, W: 445, W(no Ar): 510, D: 415, D: 565, H: 420	Seat mm: H: 440, Total mm: H: 825, W: 445, W(no Ar): 510, D: 415, D: 550, H: 420	Seat mm: H: 450, Total mm: H: 825, W: 445, W(no Ar): 510, D: 415, D: 550, H: 420	Seat mm: H: 450, Total mm: H: 825, W: 445, W(no Ar): 510, D: 415, D: 550, H: 420
Packaging data: Weight: 5,7 kg, Volume: 0,37 m ³ , Box (L x W x H): 64 x 59 x 99 cm	Packaging data: Weight: 6,3 kg, Volume: 0,37 m ³ , Box (L x W x H): 64 x 59 x 99 cm	Packaging data: Weight: 6,3 kg, Volume: 0,37 m ³ , Box (L x W x H): 64 x 59 x 99 cm	Packaging data: Weight: 5,9 kg, Volume: 0,37 m ³ , Box (L x W x H): 64 x 59 x 99 cm	Packaging data: Weight: 6,5 kg, Volume: 0,37 m ³ , Box (L x W x H): 64 x 59 x 99 cm	Packaging data: Weight: 6,9 kg, Volume: 0,37 m ³ , Box (L x W x H): 64 x 59 x 99 cm
Fabric needed (W:140 cm): Fabric: 0,5 m, Leather needed: 0,43 m ²	Fabric needed (W:140 cm): Fabric: 0,82 m, Leather needed: 0,72 m ²	Fabric needed (W:140 cm): Fabric: 0,82 m, Leather needed: 0,72 m ²	Fabric needed (W:140 cm): Fabric: 0,5 m, Leather needed: 0,41 m ²	Fabric needed (W:140 cm): Fabric: 0,95 m, Leather needed: 0,77 m ²	Fabric needed (W:140 cm): Fabric: 0,95 m, Leather needed: 0,77 m ²

Basic equipment ● / options O		Colour	Order No	Price in €	Price in €	Price in €
Seat and back cover	Not upholstered			263	-	-
	SG1 - Citadei, Era, Manhattan	See fabric chart		-	323	369
	SG2 - Lucia, King, Royal, Medley, Amalfi, Jet			-	355	432
	LG6 - Nappa leather			-	383	491
	LG7 - Semi-Aniline leather			-	411	546
Colour finish	white		3283	●	●	●
	light grey	3261	○	○	○	
	anthracite	3231	○	○	○	
Wooden parts	Wood type, finishing veneer, crosswise	beech	430	-	-	-
		oak	434	-	-	-
		American walnut	435	-	-	-
		Linking	see remark ¹	742	30 ○	30 ○
Armrests / Optional extras	Linking & panic protection	see remarks ¹	743	74 ○	74 ○	74 ○
	Armrests with plastic surface	see remarks ¹	788	158 ○	158 ○	158 ○
	Linking & armrests	see remark ¹	744	188 ○	188 ○	188 ○
	Linking, panic protection & armrests	see remarks ¹	745	232 ○	232 ○	232 ○
	Glides	Polypropylene glides for soft floors	black	820	●	●
Felt glides for hard floors		black	821	19 ○	19 ○	19 ○
Delivery	Assembled in protective cover	-	904	●	●	●
	Assembled in box	-	903	17 ○	17 ○	17 ○

Remarks:

¹ Linking = die-cast zinc, panic protection = black plastic, armrest stem = chromed aluminium, armrest surface = black plastic.

² Accessories: Seat and series numbering available on request.

Order example: standard version with various optional extras

Minimum order information			Options (O)																							
V	1	0	1	K	/	5	8	0	0	/	3	2	6	1	/	7	4	4	/	8	2	1	/	9	0	3
Basic model			Fabric		Colour finish		Armrests		Castors/Glides		Delivery															







VLEGS

Recommended price in € exclusive of VAT

VLEGSis3
Visitor chairs with writing surface on left

Standard:

- Steel frame, chromed

					
Four legged, not upholstered, plastic shell ² , stacking height: 15 pieces	Four legged, with seat upholstered, plastic shell ² , stacking height: 15 pieces	Four legged, with seat and back upholstered, plastic shell ² , stacking height: 15 pieces	Four legged, not upholstered, wooden shell ² , stacking height: 15 pieces	Four legged, with seat upholstered, wooden shell ² , stacking height: 15 pieces	Four legged, with seat and back upholstered, wooden shell ² , stacking height: 15 pieces
V110K	V111K	V112K	V110H	V111H	V112H
Seat mm H: 435 W: 445 D: 415 W(Ar) 540 D: 680 Backrest H: 420	Seat mm H: 445 W: 445 D: 415 W(Ar) 540 D: 680 Backrest H: 420	Seat mm H: 445 W: 445 D: 415 W(Ar) 540 D: 680 Backrest H: 420	Seat mm H: 440 W: 445 D: 415 W(Ar) 540 D: 665 Backrest H: 420	Seat mm H: 450 W: 445 D: 415 W(Ar) 540 D: 665 Backrest H: 420	Seat mm H: 450 W: 445 D: 415 W(Ar) 540 D: 665 Backrest H: 420
Total mm H: 820	Total mm H: 820	Total mm H: 820	Total mm H: 825	Total mm H: 825	Total mm H: 825
Volume: 0,40 m ³ Box (L x W x H): 65 x 61 x 100 cm	Volume: 0,40 m ³ Box (L x W x H): 65 x 61 x 100 cm	Volume: 0,40 m ³ Box (L x W x H): 65 x 61 x 100 cm	Volume: 0,40 m ³ Box (L x W x H): 65 x 61 x 100 cm	Volume: 0,40 m ³ Box (L x W x H): 65 x 61 x 100 cm	Volume: 0,40 m ³ Box (L x W x H): 65 x 61 x 100 cm
Fabric needed (W:140 cm) Fabric: 0,5 m Leather needed: 0,43 m ²	Fabric needed (W:140 cm) Fabric: 0,5 m Leather needed: 0,43 m ²	Fabric needed (W:140 cm) Fabric: 0,82 m Leather needed: 0,72 m ²	Fabric needed (W:140 cm) Fabric: 0,5 m Leather needed: 0,41 m ²	Fabric needed (W:140 cm) Fabric: 0,95 m Leather needed: 0,77 m ²	Fabric needed (W:140 cm) Fabric: 0,95 m Leather needed: 0,77 m ²
Weight: 7,5 kg	Weight: 8,1 kg	Weight: 8,5 kg	Weight: 7,7 kg	Weight: 8,3 kg	Weight: 8,7 kg

Basic equipment ● / options O		Colour	Order No	Price in €	Price in €	Price in €
Seat and back cover	Not upholstered			475	-	-
	SG1 - Citadei, Era, Manhattan	See fabric chart		-	532	577
	SG2 - Lucia, King, Royal, Medley, Amalfi, Jet		-	563	639	
	LG6 - Nappa leather		-	591	696	
	LG7 - Semi-Aniline leather		-	618	749	
Colour finish	Plastic parts		white	3283	●	●
		light grey	3261	○	○	
		anthracite	3231	○	○	
Wooden parts ³ & writing tablet	HPL top	premium white	4002A	●	●	●
	Wood type, writing tablet is always HPL premium white	beech	4302A	-	-	-
		oak	4342A	-	-	-
		American walnut	4352A	-	-	-
Armrests / Optional extras	Linking	see remark ¹	742	30 ○	30 ○	30 ○
	Linking & panic protection	see remarks ¹	743	74 ○	74 ○	74 ○
	Right armrest with plastic cover	see remarks ¹	788	80 ○	80 ○	80 ○
	Linking & armrests, right	see remark ¹	744	110 ○	110 ○	110 ○
	Linking, panic protection and right armrest	see remarks ¹	745	154 ○	154 ○	154 ○
	Glides	Polypropylene glides for soft floors	black	820	●	●
Felt glides for hard floors		black	821	19 ○	19 ○	19 ○
Delivery	Assembled in protective cover	-	904	●	●	●
	Assembled in box	-	903	17 ○	17 ○	17 ○

Remarks:

1 Linking = die-cast zinc, panic protection = black plastic, armrest stem = chromed aluminium, armrest surface = black plastic.

2 Accessories: Seat and series numbering available on request.

3 Writing tablet solid MDF core panel, black, top and underside HPL premium white, edge, black.

Order example: standard version with various optional extras

Minimum order information			Options (O)																								
V	1	1	2	H	/	5	8	0	0	/	4	3	4	2	A	/	7	4	2	/	8	2	0	/	9	0	3
Basic model	Fabric	Decor	Armrests	Castors/Glides	Delivery																						







VLEGS

Recommended price in € exclusive of VAT

VLEGSis3
Visitor chairs with writing surface on right

Standard:

- Steel frame, chromed

					
Four legged, not upholstered, plastic shell ² , stacking height: 15 pieces	Four legged, with seat upholstered, plastic shell ² , stacking height: 15 pieces	Four legged, with seat and back upholstered, plastic shell ² , stacking height: 15 pieces	Four legged, not upholstered, wooden shell ² , stacking height: 15 pieces	Four legged, with seat upholstered, wooden shell ² , stacking height: 15 pieces	Four legged, with seat and back upholstered, wooden shell ² , stacking height: 15 pieces
V120K	V121K	V122K	V120H	V121H	V122H
Seat mm H: 435 W: 445 D: 415	Total mm H: 820	Seat mm H: 445 W: 445 D: 415	Total mm H: 820	Seat mm H: 445 W: 445 D: 415	Total mm H: 820
W(Ar) 540 D: 680	Backrest H: 420	W(Ar) 540 D: 680	W(Ar) 540 D: 680	W(Ar) 540 D: 665	W(Ar) 540 D: 665
Packaging data Weight:7,5 kg Volume:0,40 m ³ Box (L x W x H): 65 x 61 x 100 cm	Packaging data Weight:8,1 kg Volume:0,40 m ³ Box (L x W x H): 65 x 61 x 100 cm	Packaging data Weight:8,5 kg Volume:0,40 m ³ Box (L x W x H): 65 x 61 x 100 cm	Packaging data Weight:7,7 kg Volume:0,40 m ³ Box (L x W x H): 65 x 61 x 100 cm	Packaging data Weight:8,3 kg Volume:0,40 m ³ Box (L x W x H): 65 x 61 x 100 cm	Packaging data Weight:8,7 kg Volume:0,40 m ³ Box (L x W x H): 65 x 61 x 100 cm
Fabric needed (W:140 cm) Fabric:0,5 m Leather needed:0,43 m ²	Fabric needed (W:140 cm) Fabric:0,5 m Leather needed:0,43 m ²	Fabric needed (W:140 cm) Fabric:0,82 m Leather needed:0,72 m ²	Fabric needed (W:140 cm) Fabric:0,5 m Leather needed:0,41 m ²	Fabric needed (W:140 cm) Fabric:0,95 m Leather needed:0,77 m ²	Fabric needed (W:140 cm) Fabric:0,95 m Leather needed:0,77 m ²

Basic equipment ● / options O		Colour	Order No	Price in €	Price in €	Price in €	
Seat and back cover	Not upholstered			475	-	-	
	SG1 - Citadell, Era, Manhattan	See fabric chart		-	532	577	
	SG2 - Lucia, King, Royal, Medley, Amalfi, Jet		-	563	639		
	LG6 - Nappa leather		-	591	696		
	LG7 - Semi-Aniline leather		-	618	749		
Colour finish	white		3283	●	●	●	
Wooden parts ³ & writing tablet	Wood type, writing tablet is always HPL premium white	Plastic parts	light grey	3261	○	○	
		anthracite	3231	○	○		
		HPL top	premium white	4002A	●	●	●
		beech	4302A	-	-	-	
		oak	4342A	-	-	-	
American walnut	4352A	-	-	-			
Armrests / Optional extras	Linking	see remark ¹	742	30 ○	30 ○	30 ○	
	Linking & panic protection	see remarks ¹	743	74 ○	74 ○	74 ○	
	Left armrest with plastic cover	see remarks ¹	788	80 ○	80 ○	80 ○	
	Linking & armrests, left	see remark ¹	744	110 ○	110 ○	110 ○	
	Linking, panic protection and left armrest	see remarks ¹	745	154 ○	154 ○	154 ○	
Glides	Polypropylene glides for soft floors	black	820	●	●	●	
	Felt glides for hard floors	black	821	19 ○	19 ○	19 ○	
Delivery	Assembled in protective cover	-	904	●	●	●	
	Assembled in box	-	903	17 ○	17 ○	17 ○	

Basic equipment ● / options O		Colour	Order No	Price in €	Price in €	Price in €	
Seat and back cover	Not upholstered			506	-	-	
	SG1 - Citadell, Era, Manhattan	See fabric chart		-	563	611	
	SG2 - Lucia, King, Royal, Medley, Amalfi, Jet		-	596	671		
	LG6 - Nappa leather		-	624	728		
	LG7 - Semi-Aniline leather		-	650	783		
Colour finish	white		3283	●	●	●	
Wooden parts ³ & writing tablet	Wood type, writing tablet is always HPL premium white	Plastic parts	light grey	3261	○	○	
		anthracite	3231	○	○		
		HPL top	premium white	4002A	●	●	●
		beech	4302A	-	-	-	
		oak	4342A	-	-	-	
American walnut	4352A	-	-	-			
Armrests / Optional extras	Linking	see remark ¹	742	30 ○	30 ○	30 ○	
	Linking & panic protection	see remarks ¹	743	74 ○	74 ○	74 ○	
	Left armrest with plastic cover	see remarks ¹	788	80 ○	80 ○	80 ○	
	Linking & armrests, left	see remark ¹	744	110 ○	110 ○	110 ○	
	Linking, panic protection and left armrest	see remarks ¹	745	154 ○	154 ○	154 ○	
Glides	Polypropylene glides for soft floors	black	820	●	●	●	
	Felt glides for hard floors	black	821	19 ○	19 ○	19 ○	
Delivery	Assembled in protective cover	-	904	●	●	●	
	Assembled in box	-	903	17 ○	17 ○	17 ○	

Remarks:

1 Linking = die-cast zinc, panic protection = black plastic, armrest stem = chromed aluminium, armrest surface = black plastic.

2 Accessories: Seat and series numbering available on request.

3 Writing tablet solid MDF core panel, black, top and underside HPL premium white, edge, black.

Order example: standard version with various optional extras

Minimum order information		Options (O)	
V121K	MH01	3283	744 / 821 / 904
Basic model	Fabric	Colour finish	Armrests Castors/ Glides

VLEGS

Recommended price in € exclusive of VAT

VLEGSis3
Benches 2

Standard:

- Steel frame, chromed
- Seat plate, 20 mm & rounded corners, radius 50 mm
- Frame, coated black

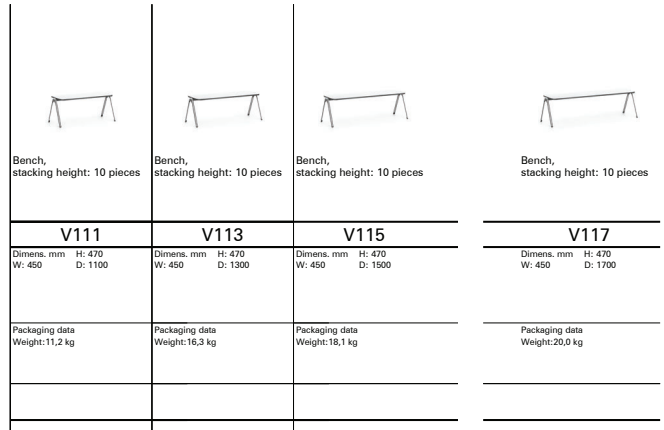

Basic equipment ●/options ○		Colour	Order No	Price in €	Price in €	Price in €	Price in €
Seat	Not upholstered			813	840	865	893
Surface	HPL, decor with 2 mm ABS edge, black	premium white	42A	●	●	●	●
		white grey	42B	○	○	○	○
		dust grey	42C	○	○	○	○
		black	42D	○	○	○	○
		maple	42E	○	○	○	○
		natural beech	42F	○	○	○	○
		light oak	42G	○	○	○	○
		light cherry	42H	○	○	○	○
		light walnut	42I	○	○	○	○
Accessories	Linking	see remark ¹	742	30 ○	30 ○	30 ○	30 ○
	Linking & panic protection	see remarks ¹	743	74 ○	74 ○	74 ○	74 ○
Glides	Polypropylene glides for soft floors	black	820	●	●	●	●
	Felt glides for hard floors	black	821	19 ○	19 ○	19 ○	19 ○

Remarks:

- ¹ Linking = die-cast zinc, panic protection = black plastic.

² Standard packaging: Wrapped in plastic film on palettes.

Order example: standard version with various optional extras

Minimum order information/Options (O)

V	1	1	3	/	4	2	D	/	7	4	3	/	8	2	1
Basic model			Decor			Armrests			Castors/ Glides						

VLEGSis3
Benches 2

Standard:

- Steel frame, chromed
- Seat upholstered
- Frame, coated black

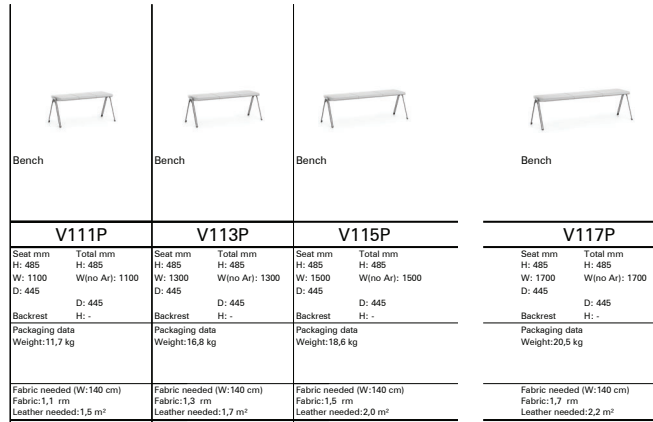

Basic equipment ●/options ○		Colour	Order No	Price in €	Price in €	Price in €	Price in €
Seat	SG1 - Citadel, Era, Manhattan	See fabric chart	742	1189	1239	1348	1460
	SG2 - Lucia, Medley, Amalfi, Jet			1208	1259	1367	1476
	SG3 - Fame, Field, Chili, Patina, Remix			1237	1287	1395	1507
	HP4 - Synergy, Rime			1266	1318	1424	1536
	LG6 - Nappa leather			1332	1382	1491	1602
	LG7 - Semi-Aniline leather			1399	1448	1557	1667
Accessories	Linking	see remark ¹	742	30 ○	30 ○	30 ○	30 ○
	Linking & panic protection	see remarks ¹	743	74 ○	74 ○	74 ○	74 ○
Glides	Polypropylene glides for soft floors	black	820	●	●	●	●
	Felt glides for hard floors	black	821	19 ○	19 ○	19 ○	19 ○

Remarks:

- 1 Linking = die-cast zinc, panic protection = black plastic.
- 2 Standard packaging: Wrapped in plastic film on palettes.

Order example: standard version with various optional extras

Minimum order information			Options (O)									
V	1	1	P	/	S	A	0	1	/	8	2	0
Basic model				Fabric				Castors/ Glides				

VLEGS

Recommended price in € exclusive of VAT

VLEGSis3
Stacking tables 2

Standard:

- Steel frame, chromed
- Table top, 20 mm & rounded corners, radius 50 mm
- Frame, coated black

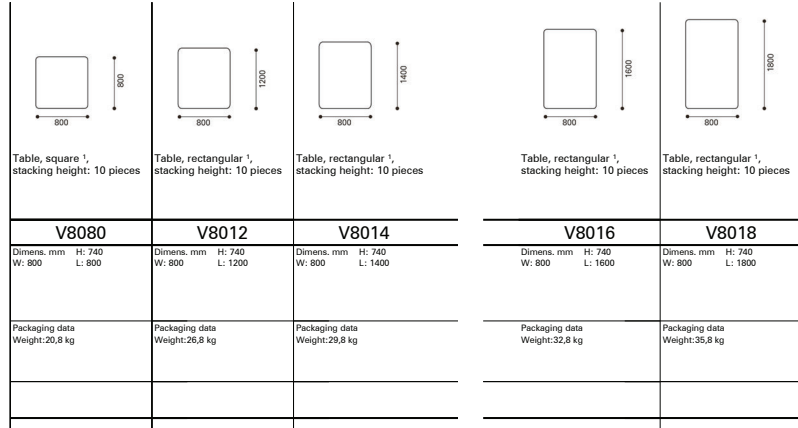

Basic equipment ●/options O		Colour	Order No	Price in €	Price in €	Price in €	Price in €	Price in €
Basic price	Basic equipment			820	983	1038	1093	1148
Table top	HPL, decor with 2 mm ABS edge, black	premium white	42A	●	●	●	●	●
		white grey	42B	○	○	○	○	○
		dust grey	42C	○	○	○	○	○
		black	42D	○	○	○	○	○
		maple	42E	○	○	○	○	○
		natural beech	42F	○	○	○	○	○
		oak	42G	○	○	○	○	○
		cherry	42H	○	○	○	○	○
		walnut	42I	○	○	○	○	○
Accessories	Linking	see remark ³	742	30 ○	30 ○	30 ○	30 ○	30 ○
	Linking & panic protection	see remarks ³	743	74 ○	74 ○	74 ○	74 ○	74 ○
Glides	Polypropylene glides for soft floors	black	820	●	●	●	●	●
	Felt glides for hard floors	black	821	19 ○	19 ○	19 ○	19 ○	19 ○

Remarks:

- 1 Accessories: Modesty panel on request.**
- 2 Standard packaging: Wrapped in plastic film on pallets.**
- 3 Linking = die-cast zinc, panic protection = black plastic.**

Order example: standard version with various optional extras



VLEGS

Recommended price in € exclusive of VAT

VLEGSis3
Benches 2

Standard:

- Steel frame, chromed
- Frame, coated black

V310	V320	V330	V312	V322	V332
Seat mm H: 470 W: 445 D: 415 Backrest H: 420	Total mm H: 855 W(no Arj): 1620 W(Arj) 1680 D: 565 Backrest H: 420	Seat mm H: 480 W: 445 D: 415 Backrest H: 420	Total mm H: 855 W(no Arj): 1620 W(Arj) 1680 D: 565 Backrest H: 420	Seat mm H: 480 W: 445 D: 415 Backrest H: 420	Total mm H: 855 W(no Arj): 1620 W(Arj) 1680 D: 565 Backrest H: 420
Packaging data Weight:23,2 kg	Packaging data Weight:23,8 kg	Packaging data Weight:24,1 kg	Packaging data Weight:23,2 kg	Packaging data Weight:23,8 kg	Packaging data Weight:24,1 kg
	Fabric needed (W:140 cm) Fabric:1,5 rm Leather needed:1,29 m²	Fabric needed (W:140 cm) Fabric:2,46 rm Leather needed:2,16 m²		Fabric needed (W:140 cm) Fabric:1,0 rm Leather needed:0,86 m²	Fabric needed (W:140 cm) Fabric:1,64 rm Leather needed:1,44 m²

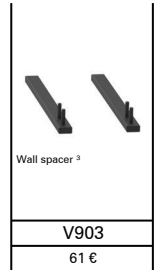

Basic equipment ●/options O		Colour	Order No	Price in €	Price in €	Price in €
Seat and back cover	Not upholstered	See fabric chart		1151	-	-
	SG1 - Citadell, Era, Manhattan		-	1322	1459	
	SG2 - Lucia, King, Royal, Medley, Amalfi, Jet		-	1416	1643	
	LG6 - Nappa leather		-	1503	1811	
	LG7 - Semi-Aniline leather		-	1582	1973	
Colour finish	Plastic parts	white	3283	●	●	●
		light grey	3261	○	○	○
		anthracite	3231	○	○	○
Table top 4	HPL compact plate	premium white	4002A	-	-	-
Armrests / Optional extras 3	Linking	see remark 1	742	30 ○	30 ○	30 ○
	Linking & panic protection	see remarks 1	743	74 ○	74 ○	74 ○
	Armrests, outer	see remarks 1	788	158 ○	158 ○	158 ○
	Linking & armrests exterior	see remark 1	744	188 ○	188 ○	188 ○
	Linking, panic protection & armrests exterior	see remarks 1	745	232 ○	232 ○	232 ○
Glides	Polypropylene glides for soft floors	black	820	●	●	●
	Felt glides for hard floors	black	821	19 ○	19 ○	19 ○

Price in €	Price in €	Price in €
1190	-	-
-	1304	1394
-	1367	1518
-	1423	1630
-	1476	1990
●	●	●
○	○	○
○	○	○
●	●	●
30 ○	30 ○	30 ○
74 ○	74 ○	74 ○
158 ○	158 ○	158 ○
188 ○	188 ○	188 ○
232 ○	232 ○	232 ○
●	●	●
19 ○	19 ○	19 ○

Remarks:

- 1 Linking = die-cast zinc, panic protection = black plastic, armrest stem = chromed aluminium, armrest surface = black plastic, can be folded up.
- 2 Standard packaging: Wrapped in plastic film on pallets.
- 3 Floor mountings & wall spacers = steel powder-coated, black.
- 4 Table top = solid MDF core panel black, top and underside HPL premium white,

edge, black.

Order example: standard version with various optional extras

Minimum order information		Options (O)	
V320	5800	3283	742 / 820
Basic model	Fabric	Colour finish	Armrests Castors/ Glides



Recommended price in € exclusive of VAT



VLEGS

VLEGSis3
Benches 2

Standard:

- Steel frame, chromed
- Frame, coated black

		
Three seater bench, not upholstered, plastic shell, table on left	Three seater bench with seat upholstery, plastic shell, table on left	Three seater bench with seat and back upholstery, plastic shell, table on left
V311	V321	V331
Seat mm H: 470 W: 445 D: 415 Backrest H: 420	Total mm H: 855 W(no Ar): 1620 W(Ar): 1650 D: 565	Seat mm H: 480 W: 445 D: 415 Backrest H: 420
Packaging data Weight: 23,1 kg		Packaging data Weight: 23,8 kg
		Fabric needed (W:140 cm) Fabric: 1,0 rm Leather needed: 0,86 m²
		Fabric needed (W:140 cm) Fabric: 1,64 rm Leather needed: 1,44 m²

		
Three seater bench, not upholstered, plastic shell, table on right	Three seater bench with seat upholstery, plastic shell, table on right	Three seater bench with seat and back upholstery, plastic shell, table on right
V313	V323	V333
Seat mm H: 470 W: 445 D: 415 Backrest H: 420	Total mm H: 855 W(no Ar): 1620 W(Ar): 1650 D: 565	Seat mm H: 480 W: 445 D: 415 Backrest H: 420
Packaging data Weight: 23,2 kg		Packaging data Weight: 23,8 kg
		Fabric needed (W:140 cm) Fabric: 1,0 rm Leather needed: 0,86 m²
		Fabric needed (W:140 cm) Fabric: 1,64 rm Leather needed: 1,44 m²

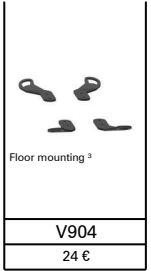
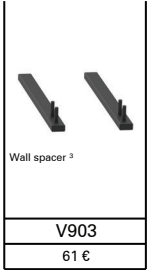

Basic equipment ●/options O		Colour	Order No	Price in €	Price in €	Price in €
Seat and back cover	Not upholstered	See fabric chart		1190	-	-
	SG1 - Citadell, Era, Manhattan			-	1304	1394
	SG2 - Lucia, King, Royal, Medley, Amalfi, Jet			-	1367	1518
	LG6 - Nappa leather			-	1423	1630
	LG7 - Semi-Aniline leather			-	1476	1990
Colour finish	Plastic parts	white	3283	●	●	●
		light grey	3261	○	○	○
		anthracite	3231	○	○	○
Table top 4	HPL compact plate	premium white	4002A	●	●	●
Accessories 3	Linking	see remark 1	742	30 ○	30 ○	30 ○
	Linking & panic protection	see remarks 1	743	74 ○	74 ○	74 ○
Glides	Polypropylene glides for soft floors	black	820	●	●	●
	Felt glides for hard floors	black	821	19 ○	19 ○	19 ○

Basic equipment ●/options O		Colour	Order No	Price in €	Price in €	Price in €
Seat and back cover	Not upholstered	See fabric chart		1190	-	-
	SG1 - Citadell, Era, Manhattan			-	1304	1394
	SG2 - Lucia, King, Royal, Medley, Amalfi, Jet			-	1367	1518
	LG6 - Nappa leather			-	1423	1630
	LG7 - Semi-Aniline leather			-	1476	1990
Colour finish	Plastic parts	white	3283	●	●	●
		light grey	3261	○	○	○
		anthracite	3231	○	○	○
Table top 4	HPL compact plate	premium white	4002A	●	●	●
Accessories 3	Linking	see remark 1	742	30 ○	30 ○	30 ○
	Linking & panic protection	see remarks 1	743	74 ○	74 ○	74 ○
Glides	Polypropylene glides for soft floors	black	820	●	●	●
	Felt glides for hard floors	black	821	19 ○	19 ○	19 ○

Remarks:

- 1 Linking = die-cast zinc, panic protection = black plastic.
- 2 Standard packaging: Wrapped in plastic film on pallets.
- 3 Floor mountings & wall spacers = steel powder-coated, black.
- 4 Table top = solid MDF core panel black, top and underside HPL premium white, edge, black.



Order example: standard version with various optional extras

Minimum order information				Options (O)			
V331	R001	3231	4002A	743	821		
Basic model	Fabric	Colour finish	Decor	Armrests	Castors/Glides		

VLEGSis3
Benches 2

Standard:

- Steel frame, chromed
- Frame, coated black

		
Two seater bench, not upholstered, plastic shell	Two seater bench with seat upholstery, plastic shell	Two seater bench with seat and back upholstery, plastic shell
V210	V220	V230
Seat mm H: 470 Total mm H: 855 W: 445 W(no Ar): 1080 D: 415 W(Ar) 1140 D: 565 Backrest H: 420	Seat mm H: 480 Total mm H: 855 W: 445 W(no Ar): 1080 D: 415 W(Ar) 1140 D: 565 Backrest H: 420	Seat mm H: 480 Total mm H: 855 W: 445 W(no Ar): 1080 D: 415 W(Ar) 1140 D: 565 Backrest H: 420
Packaging data Weight:16,6 kg	Packaging data Weight:17,2 kg	Packaging data Weight:17,6 kg
	Fabric needed (W:140 cm) Fabric:1,0 m Leather needed:0,86 m²	Fabric needed (W:140 cm) Fabric:1,64 m Leather needed:1,44 m²

Basic equipment ●/options O	Colour	Order No	Price in €	Price in €	Price in €	
Not upholstered			904	–	–	
Seat and back cover	SG1 - Citadeli, Era, Manhattan	See fabric chart	–	1018	1108	
	SG2 - Lucia, King, Royal, Medley, Amalfi, Jet		–	1080	1232	
	LG6 - Nappa leather		–	1137	1345	
	LG7 - Semi-Aniline leather		–	1190	1451	
	Colour finish		white	3283	●	●
Plastic parts	light grey	3261	○	○	○	
	anthracite	3231	○	○	○	
	Linking	see remark 1	742	30 ○	30 ○	30 ○
Armrests / 3 Optional extras	Linking & panic protection	see remarks 1	743	74 ○	74 ○	74 ○
	Armrests, outer	see remarks 1	788	158 ○	158 ○	158 ○
	Linking & armrests exterior	see remark 1	744	188 ○	188 ○	188 ○
	Linking, panic protection & armrests exterior	see remarks 1	745	232 ○	232 ○	232 ○
	Glides	Polypropylene glides for soft floors	black	820	●	●
Felt glides for hard floors		black	821	19 ○	19 ○	19 ○

Remarks:

1 Linking = die-cast zinc, panic protection = black plastic, armrest stem = chromed aluminium, armrest surface = black plastic, can be folded up.

2 Standard packaging: Wrapped in plastic film on pallets.

3 Floor mountings & wall spacers = steel powder-coated, black.

VLEGSis3

Wall spacer 3
V903
61 €

Floor mounting 3
V904
24 €

VLEGS

Order example: standard version with various optional extras







Minimum order information		Options (O)			
V230	AM01	3283	745	821	
Basic model	Fabric	Colour finish	Armrests	Castors/ Glides	

Recommended price in € exclusive of VAT

VLEGSis3
Benches 2

Standard:

- Steel frame, chromed
- Frame, coated black

	V211	V221	V231	V213	V223	V233
						
	Two seater bench, not upholstered, plastic shell, table on left	Two seater bench with seat upholstery, plastic shell, table on left	Two seater bench with seat and back upholstery, plastic shell, table on left	Two seater bench, not upholstered, plastic shell, table on right	Two seater bench with seat upholstery, plastic shell, table on right	Two seater bench with seat and back upholstery, plastic shell, table on right
	Seat mm H: 470 W: 445 D: 415 Backrest H: 420	Total mm H: 855 W(no Ar): 1080 W(Ar): 1110 D: 565 Backrest H: 420	Seat mm H: 480 W: 445 D: 415 Backrest H: 420	Total mm H: 855 W(no Ar): 1080 W(Ar): 1110 D: 565 Backrest H: 420	Seat mm H: 480 W: 445 D: 415 Backrest H: 420	Total mm H: 855 W(no Ar): 1080 W(Ar): 1110 D: 565 Backrest H: 420
	Packaging data Weight: 16,6 kg	Packaging data Weight: 17,2 kg	Packaging data Weight: 17,6 kg	Packaging data Weight: 16,6 kg	Packaging data Weight: 17,2 kg	Packaging data Weight: 17,6 kg
		Fabric needed (W:140 cm) Fabric: 0,5 m Leather needed: 0,43 m²	Fabric needed (W:140 cm) Fabric: 0,82 m Leather needed: 0,72 m²		Fabric needed (W:140 cm) Fabric: 0,5 m Leather needed: 0,43 m²	Fabric needed (W:140 cm) Fabric: 0,82 m Leather needed: 0,72 m²
	Price in €	Price in €	Price in €	Price in €	Price in €	Price in €
Basic equipment ●/options ○	944	—	—	944	—	—
Seat and back cover	Not upholstered	—	—	—	—	—
	SG1 - Citadell, Era, Manhattan	—	999	1045	—	999
	SG2 - Lucia, King, Royal, Medley, Amalfi, Jet	—	1032	1107	—	1032
	LG6 - Nappa leather	—	1060	1164	—	1060
LG7 - Semi-Aniline leather	—	1087	1216	—	1087	1216
Colour finish	white	3283	●	●	●	●
	Plastic parts	light grey	3261	○	○	○
	anthracite	3231	○	○	○	○
Table top 4	HPL compact plate	premium white	4002A	●	●	●
Accessories 3	Linking	see remark 1	742	30 ○	30 ○	30 ○
	Linking & panic protection	see remarks 1	743	74 ○	74 ○	74 ○
Glides	Polypropylene glides for soft floors	black	820	●	●	●
	Felt glides for hard floors	black	821	19 ○	19 ○	19 ○

VLEGSis3



Wall spacer 3

V903

61 €



Floor mounting 3

V904

24 €

Remarks:

- 1 Linking = die-cast zinc, panic protection = black plastic.
- 2 Standard packaging: Wrapped in plastic film on palettes.
- 3 Floor mountings & wall spacers = steel powder-coated, black.
- 4 Table top = solid MDF core panel black, top and underside HPL premium white, edge, black.

Order example: standard version with various optional extras

Minimum order information			Options (O)							
V2311	/	5800	/	3283	/	4002A	/	743	/	820
Basic model		Fabric		Colour finish		Decor		Armrests		Castors/ Glides

Recommended price in € exclusive of VAT

VLEGS



SU234



SU152



SU161

SHUFFLE

Quality:



Warranty (10 year)



Tested safety



BIFMA compliant

Environment:



Quality produced for the environment



Tested for contaminants



The Blue Angel
www.blauer-engel.de/uz117

Product design Ballendat, Simbach am Inn



Bifma e3
level Platin









Level 3
European Sustainability
Certificate
- highest level

SHUFFLEis1
Visitor chairs

Standard:

- Plastic shell
- Stacking protector included for models with four legs, cantilever and sled base

						
Four legs, stacking height: 5 pieces	Pyramid base	Four legs, wood	Cantilever frame, stacking height: 5 pieces	Sled-base, stacking height: 5 pieces	Swivel chair with four star base	Swivel chair with base five-arm
SU111	SU171	SU161	SU121	SU131	SU141	SU151
Seat mm: H: 430, Total mm: H: 825, W: 460, W(no Ar): 540, D: 450, W(Ar): 580, D: 515, Backrest: H: 400	Seat mm: H: 430, Total mm: H: 825, W: 460, W(no Ar): 540, D: 450, W(Ar): 580, D: 515, Backrest: H: 400	Seat mm: H: 430, Total mm: H: 825, W: 460, W(no Ar): 460, D: 450, W(Ar): 580, D: 515, Backrest: H: 400	Seat mm: H: 440, Total mm: H: 850, W: 460, W(no Ar): 500, D: 450, W(Ar): 580, D: 545, Backrest: H: 400	Seat mm: H: 440, Total mm: H: 850, W: 460, W(no Ar): 500, D: 450, W(Ar): 580, D: 545, Backrest: H: 400	Seat mm: H: 420, Total mm: H: 835, W: 460, W(no Ar): 470, D: 450, W(Ar): 580, D: 515, Backrest: H: 400	Seat mm: H: 365-465, Total mm: H: 860, W: 460, W(no Ar): 465, D: 450, W(Ar): 580, D: 515, Backrest: H: 400
Packaging data: Weight: 5.5 kg, Volume: 0.3 m³, Box (L x W x H): 64 x 59 x 80 cm	Packaging data: Weight: 5.1 kg, Volume: 0.3 m³, Box (L x W x H): 64 x 59 x 80 cm	Packaging data: Weight: 5.1 kg, Volume: 0.3 m³, Box (L x W x H): 64 x 59 x 80 cm	Packaging data: Weight: 7.4 kg, Volume: 0.3 m³, Box (L x W x H): 64 x 59 x 80 cm	Packaging data: Weight: 6.8 kg, Volume: 0.3 m³, Box (L x W x H): 64 x 59 x 80 cm	Packaging data: Weight: 5.9 kg, Volume: 0.3 m³, Box (L x W x H): 64 x 59 x 80 cm	Packaging data: Weight: 6.5 kg, Volume: 0.3 m³, Box (L x W x H): 64 x 59 x 80 cm

Basic equipment ●/options ○		Colour	Order No	Price in €	Price in €	Price in €
Basic price	Not upholstered			184	184	332
Frame	Steel	black	2217	●	●	–
		white	2283	○	○	–
		chromed	2324	25 ○	25 ○	–
	Wood	oak	434	–	–	●
Shell	Polyamide	white	3283	●	●	●
		black	3217	○	○	○
		petrol	3A01	○	○	○
		grey-blue	3A02	○	○	○
		nude	3A03	○	○	○
		mustard	3A04	○	○	○
Base	Aluminium	black	563217	–	–	–
		white	563283	–	–	–
		polished	563304	–	–	87 ○
		black	521217	–	–	–
		white	521283	–	–	–
		polished	521304	–	–	87 ○
Armrests / Optional extras	Loop armrests	see remark ²	701	137 ○	137 ○	137 ○
	Open armrests	see remark ²	702	92 ○	92 ○	92 ○
	Linking	see remark ²	742	60 ○	–	–
	Open armrest with linking	see remark ²	744	152 ○	–	–
	Loop armrests with linking	see remark ²	746	197 ○	–	–
Castors/Glides	Hard glides for soft floors	black	820	●	●	●
	Soft glides for hard floors	black	821	18 ○	18 ○	18 ○
	Hard double castors	black	802	–	–	–
	Soft double castors	black	801	–	–	–
Delivery	Assembled in protective cover	-	904	●	●	●
	Assembled in box	-	903	17 ○	17 ○	17 ○

Price in €	Price in €	Price in €	Price in €
240	240	332	332
●	●	–	–
○	○	–	–
25 ○	25 ○	–	–
–	–	–	–
●	●	●	●
○	○	○	○
○	○	○	○
○	○	○	○
○	○	○	○
–	–	●	–
–	–	○	–
–	–	87 ○	–
–	–	–	●
–	–	–	○
–	–	–	87 ○
137 ○	137 ○	137 ○	137 ○
92 ○	92 ○	92 ○	92 ○
–	60 ○	–	–
–	152 ○	–	–
–	197 ○	–	–
–	–	●	–
18 ○	18 ○	18 ○	–
–	–	○	●
–	–	○	○
●	●	●	●
17 ○	17 ○	17 ○	17 ○

Remarks:

- 1 Felt glides for cantilever, transparent.
- 2 Row connector = chrome-plated, loop armrests & open armrests = same colour as frame.
The models with loop armrests are not stackable. Models with sled base frame are only stackable without armrests.
- 3 Base black or white = castors black, Base polished = castors chrome lock.

Order example: standard version with various optional extras

Minimum order information/Options (O)

SU111	/	2217	/	3283	/	820	/	904
Basic model		Colour finish/ Metal parts		Colour finish		Castors/ Glides		Delivery







Recommended price in € exclusive of VAT

SHUFFLE

SHUFFLEis1
Visitor chairs

Standard:

- Plastic shell with upholstered seat
- Stacking protector included for models with four legs, cantilever and sled base

SU112		SU172		SU162		SU122		SU132		SU142		SU152	
													
Four legs, stacking height: 5 pieces		Pyramid base		Four legs, wood		Cantilever frame, stacking height: 5 pieces		Sled-base, stacking height: 5 pieces		Swivel chair with four star base		Swivel chair with base five-arm	
Seat mm H: 440 W: 460 D: 450	Total mm H: 825 W(no Ar): 540 W(Ar) 580 D: 515	Seat mm H: 440 W: 460 D: 450	Total mm H: 825 W(no Ar): 540 W(Ar) 580 D: 515	Seat mm H: 440 W: 460 D: 450	Total mm H: 825 W(no Ar): 460 W(Ar) 580 D: 515	Seat mm H: 450 W: 460 D: 450	Total mm H: 850 W(no Ar): 510 W(Ar) 580 D: 545	Seat mm H: 445 W: 460 D: 450	Total mm H: 825 W(no Ar): 500 W(Ar) 580 D: 535	Seat mm H: 425 W: 460 D: 450	Total mm H: 810 W(no Ar): 460 W(Ar) 580 D: 515	Seat mm H: 375-475 W: 460 D: 450	Total mm H: 851 W(no Ar): 460 W(Ar) 580 D: 515
Packaging data Weight: 6,4 kg Volume: 0,3 m³ Box (L x W x H): 64 x 59 x 80 cm		Packaging data Weight: 5,9 kg Volume: 0,3 m³ Box (L x W x H): 64 x 59 x 80 cm		Packaging data Weight: 6 kg Volume: 0,3 m³ Box (L x W x H): 64 x 59 x 80 cm		Packaging data Weight: 8,3 kg Volume: 0,3 m³ Box (L x W x H): 64 x 59 x 80 cm		Packaging data Weight: 7,7 kg Volume: 0,3 m³ Box (L x W x H): 64 x 59 x 80 cm		Packaging data Weight: 6,8 kg Volume: 0,3 m³ Box (L x W x H): 64 x 59 x 80 cm		Packaging data Weight: 7,3 kg Volume: 0,3 m³ Box (L x W x H): 64 x 59 x 80 cm	
Fabric needed (W:140 cm) Fabric: 0,52 m Leather needed: 0,40 m²		Fabric needed (W:140 cm) Fabric: 0,52 m Leather needed: 0,40 m²		Fabric needed (W:140 cm) Fabric: 0,52 m Leather needed: 0,40 m²		Fabric needed (W:140 cm) Fabric: 0,52 m Leather needed: 0,40 m²		Fabric needed (W:140 cm) Fabric: 0,52 m Leather needed: 0,40 m²		Fabric needed (W:140 cm) Fabric: 0,52 m Leather needed: 0,40 m²		Fabric needed (W:140 cm) Fabric: 0,52 m Leather needed: 0,40 m²	

Basic equipment ●/options O		Colour	Order No	Price in €	Price in €	Price in €
Seat cover	SG1 - Citadel, Era, Manhattan	See fabric chart		244	244	392
	SG2 - Lucia, King, Royal, Medley, Amalfi, Fabric provided, Jot		269	269	418	
	SG3 - Fame, Field, Chili, Patina, Remix		293	293	443	
Frame	Steel	black	2217	●	●	—
		white	2283	○	○	—
	Wood	chromed	2324	25 ○	25 ○	—
		oak	434	—	—	●
Shell	Polyamide	white	3283	●	●	●
		black	3217	○	○	○
		petrol	3A01	○	○	○
		grey-blue	3A02	○	○	○
		nude	3A03	○	○	○
		mustard	3A04	○	○	○
Base	Aluminium	black	563217	—	—	—
		white	563283	—	—	—
		polished	563304	—	—	—
		black	521217	—	—	—
		white	521283	—	—	—
		polished	521304	—	—	—
Armrests / Optional extras	Loop armrests	see remark ²	701	137 ○	137 ○	137 ○
	Open armrests	see remark ³	702	92 ○	92 ○	92 ○
	Linking	see remark ²	742	60 ○	—	—
	Open armrest with linking	see remark ²	744	152 ○	—	—
	Loop armrests with linking	see remark ²	746	197 ○	—	—
Castors/Glides	Hard glides for soft floors	black	820	●	●	●
	Soft glides for hard floors	black	821	18 ○	18 ○	18 ○
	Hard double castors	black	802	—	—	—
	Soft double castors	black	801	—	—	—
Delivery	Assembled in protective cover	-	904	●	●	●
	Assembled in box	-	903	17 ○	17 ○	17 ○

Price in €	Price in €	Price in €	Price in €
300	300	392	392
325	325	418	418
350	350	443	443
●	●	—	—
○	○	—	—
25 ○	25 ○	—	—
—	—	—	—
●	●	●	●
○	○	○	○
○	○	○	○
○	○	○	○
○	○	○	○
○	○	○	○
—	—	●	—
—	—	○	—
—	—	87 ○	—
—	—	—	●
—	—	—	○
—	—	—	87 ○
137 ○	137 ○	137 ○	137 ○
92 ○	92 ○	92 ○	92 ○
—	60 ○	—	—
—	152 ○	—	—
—	197 ○	—	—
—	—	●	—
18 ○	18 ○	18 ○	—
—	—	○	●
—	—	○	○
●	●	●	●
17 ○	17 ○	17 ○	17 ○

Remarks:

1 Felt glides for cantilever, transparent.

2 Row connector = chrome-plated, loop armrests & open armrests = same colour as frame.

The models with loop armrests are not stackable. Models with sled base frame are only stackable without armrests.

3 Base black or white = castors black, Base polished = castors chrome lock.

Order example: standard version with various optional extras

Minimum order information		Options (O)					
SU1162	MH01	21459	3283	821	903		
Basic model	Fabric	Colour finish/ Metal parts	Colour finish	Castors/ Glides	Delivery		







Recommended price in € exclusive of VAT

SHUFFLE

SHUFFLEis1
Visitor chairs

Standard:

- Plastic shell with fully upholstered seat and backrest
- Stacking protector included for models with four legs, cantilever and sled base

SU113		SU173		SU163		SU123		SU133		SU143		SU153	
													
Four legs, stacking height: 5 pieces		Pyramid base		Four legs, wood		Cantilever frame, stacking height: 5 pieces		Sled-base, stacking height: 5 pieces		Swivel chair with four star base		Swivel chair with base five-arm	
Seat mm H: 440 W: 460 D: 450	Total mm H: 825 W(no Ar): 540 W(Ar): 580 D: 515	Seat mm H: 440 W: 460 D: 450	Total mm H: 825 W(no Ar): 460 W(Ar): 580 D: 515	Seat mm H: 440 W: 460 D: 515	Total mm H: 825 W(no Ar): 460 W(Ar): 580 D: 515	Seat mm H: 450 W: 460 D: 450	Total mm H: 835 W(no Ar): 500 W(Ar): 580 D: 545	Seat mm H: 440 W: 460 D: 450	Total mm H: 825 W(no Ar): 510 W(Ar): 580 D: 535	Seat mm H: 425 W: 460 D: 450	Total mm H: 815 W(no Ar): 460 W(Ar): 580 D: 515	Seat mm H: 365-465 W: 460 D: 450	Total mm H: 850 W(no Ar): 460 W(Ar): 580 D: 515
Backrest H: 400		Backrest H: 400		Backrest H: 400		Backrest H: 400		Backrest H: 400		Backrest H: 400		Backrest H: 400	
Packaging data Weight: 7,2 kg Volume: 0,3 m³ Box (L x W x H): 64 x 59 x 80 cm		Packaging data Weight: 6,8 kg Volume: 0,3 m³ Box (L x W x H): 64 x 59 x 80 cm		Packaging data Weight: 6,8 kg Volume: 0,3 m³ Box (L x W x H): 64 x 59 x 80 cm		Packaging data Weight: 8,5 kg Volume: 0,3 m³ Box (L x W x H): 64 x 59 x 80 cm		Packaging data Weight: 8,6 kg Volume: 0,3 m³ Box (L x W x H): 64 x 59 x 80 cm		Packaging data Weight: 7,6 kg Volume: 0,3 m³ Box (L x W x H): 64 x 59 x 80 cm		Packaging data Weight: 8,2 kg Volume: 0,3 m³ Box (L x W x H): 64 x 59 x 80 cm	
Fabric needed (W:140 cm) Fabric: 0,52 m Leather needed: 0,80 m²		Fabric needed (W:140 cm) Fabric: 0,52 m Leather needed: 0,80 m²		Fabric needed (W:140 cm) Fabric: 0,52 m Leather needed: 0,80 m²		Fabric needed (W:140 cm) Fabric: 0,52 m Leather needed: 0,80 m²		Fabric needed (W:140 cm) Fabric: 0,52 m Leather needed: 0,80 m²		Fabric needed (W:140 cm) Fabric: 0,52 m Leather needed: 0,80 m²		Fabric needed (W:140 cm) Fabric: 0,52 m Leather needed: 0,80 m²	

Basic equipment ● / options ○		Colour	Order No	Price in €	Price in €	Price in €
Seat and back cover	SG1 - Citadel, Era, Manhattan	See fabric chart		301	301	449
	SG2 - Lucia, King, Royal, Medley, Amalfi, Fabric provided, Jot		352	352	499	
	SG3 - Fame, Field, Chili, Patina, Remix		401	401	548	
Frame	Steel	black	2217	●	●	–
		white	2283	○	○	–
	Wood	chromed	2324	25 ○	25 ○	–
		oak	434	–	–	●
Shell	Polyamide	white	3283	●	●	●
		black	3217	○	○	○
		petrol	3A01	○	○	○
		grey-blue	3A02	○	○	○
		nude	3A03	○	○	○
		mustard	3A04	○	○	○
Base	Aluminium	black	563217	–	–	–
		white	563283	–	–	–
		polished	563304	–	–	–
		black	521217	–	–	–
		white	521283	–	–	–
		polished	521304	–	–	–
Armrests / Optional extras	Loop armrests	see remark ²	701	137 ○	137 ○	137 ○
	Open armrests	see remark ³	702	92 ○	92 ○	92 ○
	Linking	see remark ²	742	60 ○	–	–
	Open armrest with linking	see remark ²	744	152 ○	–	–
	Loop armrests with linking	see remark ²	746	197 ○	–	–
Castors/Glides	Hard glides for soft floors	black	820	●	●	●
	Soft glides for hard floors	black	821	18 ○	18 ○	18 ○
	Hard double castors	black	802	–	–	–
	Soft double castors	black	801	–	–	–
Delivery	Assembled in protective cover	-	904	●	●	●
	Assembled in box	-	903	17 ○	17 ○	17 ○

Price in €	Price in €	Price in €	Price in €
357	357	449	449
406	406	499	499
455	455	548	548
●	●	–	–
○	○	–	–
25 ○	25 ○	–	–
–	–	–	–
●	●	●	●
○	○	○	○
○	○	○	○
○	○	○	○
○	○	○	○
○	○	○	○
–	–	●	–
–	–	○	–
–	–	87 ○	–
–	–	–	●
–	–	–	○
–	–	–	87 ○
137 ○	137 ○	137 ○	137 ○
92 ○	92 ○	92 ○	92 ○
–	60 ○	–	–
–	152 ○	–	–
–	197 ○	–	–
–	–	●	–
18 ○	18 ○	18 ○	–
–	–	○	●
–	–	○	○
●	●	●	●
17 ○	17 ○	17 ○	17 ○

Remarks:

1 Felt glides for cantilever, transparent.

2 Row connector = chrome-plated, loop armrests & open armrests = same colour as frame.

The models with loop armrests are not stackable. Models with sled base frame are only stackable without armrests.

3 Base black or white = castors black, Base polished = castors chrome lock.

Order example: standard version with various optional extras

Minimum order information				Options (O)																									
S	U	1	4	3	/	5	8	0	0	/	3	2	1	7	/	5	6	3	2	1	7	/	8	0	1	/	9	0	4
Basic model				Fabric	Colour finish	Base	Castors/Glides	Delivery																					







Recommended price in € exclusive of VAT

SHUFFLE

SHUFFLEis1
Visitor chairs

Standard:

- Plastic shell fully upholstered
- Stacking protector included for models with four legs, cantilever and sled base

						
Four legs, stacking height: 5 pieces	Pyramid base	Four legs, wood	Cantilever frame, stacking height: 5 pieces	Sled-base, stacking height: 5 pieces	Swivel chair with four star base	Swivel chair with base five-arm
SU114	SU174	SU164	SU124	SU134	SU144	SU154
Seat mm: H: 440, Total mm: H: 825, W: 460, W(no Ar): 540, W(Ar): 580, D: 450, D: 515, Backrest: H: 400	Seat mm: H: 440, Total mm: H: 825, W: 460, W(no Ar): 540, W(Ar): 580, D: 450, D: 515, Backrest: H: 400	Seat mm: H: 440, Total mm: H: 825, W: 460, W(no Ar): 460, W(Ar): 580, D: 450, D: 515, Backrest: H: 400	Seat mm: H: 450, Total mm: H: 830, W: 460, W(no Ar): 500, W(Ar): 580, D: 450, D: 545, Backrest: H: 400	Seat mm: H: 440, Total mm: H: 825, W: 460, W(no Ar): 510, W(Ar): 580, D: 450, D: 525, Backrest: H: 400	Seat mm: H: 425, Total mm: H: 810, W: 460, W(no Ar): 460, W(Ar): 580, D: 450, D: 515, Backrest: H: 400	Seat mm: H: 375-475, Total mm: H: 860, W: 460, W(no Ar): 460, W(Ar): 580, D: 450, D: 515, Backrest: H: 400
Packaging data: Weight: 8,6 kg, Volume: 0,3 m³, Box (L x W x H): 64 x 59 x 80 cm, Fabric needed (W: 140 cm): Fabric: 0,96 m, Leather needed: 1,60 m²	Packaging data: Weight: 8,1 kg, Volume: 0,3 m³, Box (L x W x H): 64 x 59 x 80 cm, Fabric needed (W: 140 cm): Fabric: 0,96 m, Leather needed: 1,60 m²	Packaging data: Weight: 8,2 kg, Volume: 0,3 m³, Box (L x W x H): 64 x 59 x 80 cm, Fabric needed (W: 140 cm): Fabric: 0,96 m, Leather needed: 1,60 m²	Packaging data: Weight: 10,4 kg, Volume: 0,3 m³, Box (L x W x H): 64 x 59 x 80 cm, Fabric needed (W: 140 cm): Fabric: 0,96 m, Leather needed: 1,60 m²	Packaging data: Weight: 9,9 kg, Volume: 0,3 m³, Box (L x W x H): 64 x 59 x 80 cm, Fabric needed (W: 140 cm): Fabric: 0,96 m, Leather needed: 1,60 m²	Packaging data: Weight: 8,9 kg, Volume: 0,3 m³, Box (L x W x H): 64 x 59 x 80 cm, Fabric needed (W: 140 cm): Fabric: 0,96 m, Leather needed: 1,60 m²	Packaging data: Weight: 9,5 kg, Volume: 0,3 m³, Box (L x W x H): 64 x 59 x 80 cm, Fabric needed (W: 140 cm): Fabric: 0,96 m, Leather needed: 1,60 m²

Basic equipment ●/options ○		Colour	Order No	Price in €	Price in €	Price in €
Seat and back cover	SG1 - Citadel, Era, Manhattan	See fabric chart		421	421	569
	SG2 - Lucia, King, Royal, Medley, Amalfi, Fabric provided, Jot		476	476	625	
	SG3 - Fame, Field, Chili, Patina, Remix		532	532	680	
Frame	Steel	black	2217	●	●	–
	Wood	white	2283	○	○	–
chromed		2324	25 ○	25 ○	–	
oak		434	–	–	●	
Base	Aluminium	black	563217	–	–	–
		white	563283	–	–	–
		polished	563304	–	–	–
		black	521217	–	–	–
		white	521283	–	–	–
		polished	521304	–	–	–
Armrests / Optional extras	Loop armrests	see remark ²	701	137 ○	137 ○	137 ○
	Open armrests	see remark ²	702	92 ○	92 ○	92 ○
	Linking	see remark ²	742	60 ○	–	–
	Open armrest with linking	see remark ²	744	152 ○	–	–
	Loop armrests with linking	see remark ²	746	197 ○	–	–
Castors/Glides	Hard glides for soft floors	black	820	●	●	●
	Soft glides for hard floors	black ¹	821	18 ○	18 ○	18 ○
	Hard double castors	black ³	802	–	–	–
	Soft double castors	black ³	801	–	–	–
Delivery	Assembled in protective cover	-	904	●	●	●
	Assembled in box	-	903	17 ○	17 ○	17 ○

Price in €	Price in €	Price in €	Price in €
476	476	569	569
532	532	625	625
588	588	680	680
●	●	–	–
○	○	–	–
25 ○	25 ○	–	–
–	–	–	–
–	–	●	–
–	–	○	–
–	–	87 ○	–
–	–	–	●
–	–	–	○
–	–	–	87 ○
137 ○	137 ○	137 ○	137 ○
92 ○	92 ○	92 ○	92 ○
–	60 ○	–	–
–	152 ○	–	–
–	197 ○	–	–
–	–	●	–
18 ○	18 ○	18 ○	–
–	–	○	●
–	–	○	○
●	●	●	●
17 ○	17 ○	17 ○	17 ○

Remarks:

1 Felt glides for cantilever, transparent.

2 Row connector = chrome-plated, loop armrests & open armrests = same colour as frame.

The models with loop armrests are not stackable. Models with sled base frame are only stackable without armrests.

3 Base black or white = castors black, Base polished = castors chrome lock.



Order example: standard version with various optional extras

Minimum order information				Options (O)																		
S	U	1	3	4	/	5	8	0	0	/	2	3	2	4	/	8	2	1	/	9	0	3
Basic model				Fabric	Colour finish/ Metal parts	Castors/ Glides		Delivery														

SHUFFLEis1
Bar stools

Standard:

- Plastic shell

 Four legs	 Four legs, wood	 Sled-base, stacking height: 4 pieces
SU271	SU261	SU231
Seat mm: H: 755 W: 455 D: 420 Total mm: H: 1005 W(no Ar): 455 D: 420 Backrest: H: 250	Seat mm: H: 755 W: 455 D: 420 Total mm: H: 1005 W(no Ar): 455 D: 495 Backrest: H: 250	Seat mm: H: 755 W: 450 D: 420 Total mm: H: 1005 W(no Ar): 500 D: 515 Backrest: H: 250
Packaging data Weight: 6,8 kg Volume: 0,4 m³ Box (L x W x H): 64 x 59 x 110 cm	Packaging data Weight: 6,5 kg Volume: 0,4 m³ Box (L x W x H): 64 x 59 x 110 cm	Packaging data Weight: 8,5 kg Volume: 0,4 m³ Box (L x W x H): 64 x 59 x 110 cm

Basic equipment ● / options ○		Colour	Order No	Price in €	Price in €	Price in €
Basic price	Not upholstered			258	489	314
Frame	Steel	black	2217	●	–	●
		white	2283	○	–	○
		chromed	2324	49 ○	–	49 ○
	Wood	oak	434	–	●	–
Shell	Polyamide	white	3283	●	●	●
		black	3217	○	○	○
		petrol	3A01	○	○	○
		grey-blue	3A02	○	○	○
		nude	3A03	○	○	○
mustard	3A04	○	○	○		
Glides	Hard glides for soft floors	black	820	●	●	–
	Soft glides for hard floors	black	821	○	○	○
Delivery	Assembled in protective cover	-	904	●	●	●
	Assembled in box	-	903	17 ○	17 ○	17 ○

Order example: standard version with various optional extras

Minimum order information/Options (O)

S	U	2	3	1	/	2	2	8	3	/	3	2	8	3	/	8	2	0	/	9	0	4		
Basic model						Colour finish/ Metal parts						Colour finish						Castors/ Glides				Delivery		

SHUFFLEis1
Bar stools

Standard:

- Plastic shell with upholstered seat

 Four legs	 Four legs, wood	 Sled-base, stacking height: 4 pieces
SU272	SU262	SU232
Seat mm: H: 765, W: 455, D: 420 Total mm: H: 1005, W(no Ar): 455 Backrest: H: 250 Packaging data: Weight: 7,6 kg, Volume: 0,4 m³, Box (L x W x H): 64 x 59 x 110 cm Fabric needed (W:140 cm): Fabric: 0,49 m, Leather needed: 0,38 m²	Seat mm: H: 765, W: 455, D: 420 Total mm: H: 1005, W(no Ar): 455 Backrest: H: 250 Packaging data: Weight: 7,3 kg, Volume: 0,4 m³, Box (L x W x H): 64 x 59 x 110 cm Fabric needed (W:140 cm): Fabric: 0,49 m, Leather needed: 0,38 m²	Seat mm: H: 765, W: 455, D: 420 Total mm: H: 1005, W(no Ar): 500 D: 515 Backrest: H: 250 Packaging data: Weight: 9,3 kg, Volume: 0,4 m³, Box (L x W x H): 64 x 59 x 110 cm Fabric needed (W:140 cm): Fabric: 0,49 m, Leather needed: 0,38 m²

Basic equipment ● / options ○		Colour	Order No	Price in €	Price in €	Price in €
Seat cover	SG1 - Citadel, Era, Manhattan	See fabric chart		●	●	●
	SG2 - Lucia, King, Royal, Medley, Amalfi, Fabric provided, Jot		○	○	○	
	SG3 - Fame, Field, Chili, Patina, Remix		○	○	○	
Frame	Steel	black	2217	●	—	●
		white	2283	○	—	○
	chromed	2324	49 ○	—	49 ○	
	Wood	oak	434	—	●	—
Shell	Polyamide	white	3283	●	●	●
		black	3217	○	○	○
		petrol	3A01	○	○	○
		grey-blue	3A02	○	○	○
		nude	3A03	○	○	○
Glides	Hard glides for soft floors	black	820	●	●	—
		Soft glides for hard floors	black	821	○	○
Delivery	Assembled in protective cover	-	904	●	●	●
	Assembled in box	-	903	17 ○	17 ○	17 ○



Order example: standard version with various optional extras

Minimum order information				Options (O)						
SU272	/	RO01	/	2283	/	3283	/	820	/	904
Basic model		Fabric		Colour finish/ Metal parts		Colour finish		Castors/ Glides		Delivery

SHUFFLEis1
Bar stools

Standard:

- Plastic shell fully upholstered

		
Four legs	Four legs, wood	Sled-base, stacking height: 4 pieces
SU274	SU264	SU234
Seat mm: H: 75 W: 455 D: 420 Total mm: H: 1005 W(no Ar): 455	Seat mm: H: 765 W: 455 D: 420 Total mm: H: 10005 W(no Ar): 455	Seat mm: H: 765 W: 500 D: 420 Total mm: H: 1005 W(no Ar): 500
Backrest: H: 250	Backrest: H: 250	Backrest: H: 250
Packaging data Weight: 9,5 kg Volume: 0,4 m³ Box (L x W x H): 64 x 59 x 110 cm	Packaging data Weight: 9,2 kg Volume: 0,4 m³ Box (L x W x H): 64 x 59 x 110 cm	Packaging data Weight: 11,2 kg Volume: 0,4 m³ Box (L x W x H): 64 x 59 x 110 cm
Fabric needed (W:140 cm) Fabric: 0,75 m Leather needed: 1,26 m²	Fabric needed (W:140 cm) Fabric: 0,75 m Leather needed: 1,26 m²	Fabric needed (W:140 cm) Fabric: 0,75 m Leather needed: 1,26 m²

Basic equipment ● / options ○		Colour	Order No	Price in €	Price in €	Price in €
Seat and back cover	SG1 - Citadel, Era, Manhattan	See fabric chart		496	726	550
	SG2 - Lucia, King, Royal, Medley, Amalfi, Fabric provided, Jot		545	774	600	
	SG3 - Fame, Field, Chili, Patina, Remix		593	825	649	
Frame	Steel	black	2217	●	–	●
		white	2283	○	–	○
Frame	Wood	chromed	2324	49 ○	–	49 ○
		oak	434	–	●	–
Glides	Hard glides for soft floors	black	820	●	●	–
	Soft glides for hard floors	black	821	○	○	○
Delivery	Assembled in protective cover	-	904	●	●	●
	Assembled in box	-	903	17 ○	17 ○	17 ○

Order example: standard version with various optional extras

Minimum order information				Options (O)																		
S	U	2	7	4	/	C	1	0	1	/	2	2	1	7	/	8	2	0	/	9	0	3
Basic model				Fabric	Colour finish/ Metal parts	Castors/ Glides		Delivery														

SHUFFLEis1
Bridges ¹

Standard:

- Board thickness 40 mm (glued frame)

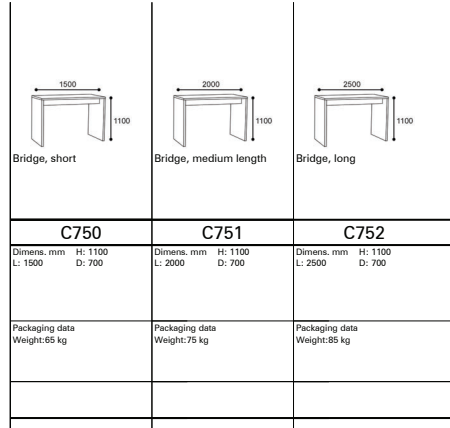

C750	C751	C752
Dimens. mm H: 1100 L: 1500 D: 700	Dimens. mm H: 1100 L: 2000 D: 700	Dimens. mm H: 1100 L: 2500 D: 700
Packaging data Weight:65 kg	Packaging data Weight:75 kg	Packaging data Weight:85 kg

Basic equipment ● / options ○		Colour	Order No	Price in €	Price in €	Price in €
Basic price	Basic equipment			1620	1746	2211
Table top	HPL plast.surf.with 2 mm ABS the same.col.as the top	premium white	42A	●	●	●
Glides	All-purpose glides	white	820	●	●	●

Remarks:

¹ Standard packaging: Wrapped in plastic film on palettes.

Order example: standard version with various optional extras

Minimum order information/Options (O)

C752	/	42A	/	820
Basic model		Decor		Castors/ Glides

SHUFFLEis1
Lounge chair

Standard:

- Plastic shell

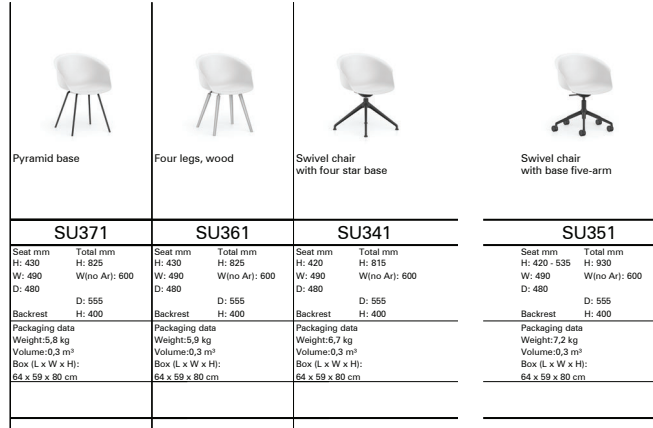

SU371	SU361	SU341	SU351
-------	-------	-------	-------

Basic equipment ●/options ○		Colour	Order No	Price in €	Price in €	Price in €	Price in €
Basic price	Not upholstered			244	392	392	392
Frame	Steel	black	2217	●	—	—	—
		white	2283	○	—	—	—
		chromed	2324	25 ○	—	—	—
		oak	434	—	●	—	—
Shell	Polyamide	white	3283	●	●	●	●
		black	3217	○	○	○	○
		petrol	3A01	○	○	○	○
		grey-blue	3A02	○	○	○	○
		nude	3A03	○	○	○	○
		mustard	3A04	○	○	○	○
Base	Aluminium	black	563217	—	—	●	—
		white	563283	—	—	○	—
		polished	563304	—	—	87 ○	—
		black	521217	—	—	—	●
		white	521283	—	—	—	○
		polished	521304	—	—	—	87 ○
Castors/Glides	Hard glides for soft floors	black	820	●	●	●	—
	Soft glides for hard floors	black	821	18 ○	18 ○	18 ○	—
	Hard double castors	black	802	—	—	—	●
	Soft double castors	black	801	—	—	—	○
Delivery	Assembled in protective cover	-	904	●	●	●	●
	Assembled in box	-	903	17 ○	17 ○	17 ○	17 ○

Remarks:
1 Base black or white = castors black,
Base polished = castors chrome look.





Order example: standard version with various optional extras

Minimum order information/Options (O)																								
S	U	3	5	1	/	3	2	8	3	/	5	2	1	2	1	7	/	8	0	1	/	9	0	3
Basic model				Colour finish				Base				Castors/Glides				Delivery								

SHUFFLEis1
Lounge chair

Standard:

- Plastic shell with upholstered seat

 Pyramid base	 Four legs, wood	 Swivel chair with four star base	 Swivel chair with base five-arm
SU372	SU362	SU342	SU352
Seat mm H: 445 W: 490 D: 480	Seat mm H: 445 W: 490 D: 480	Seat mm H: 435 W: 490 D: 480	Seat mm H: 435 - 550 W: 490 D: 480
Total mm H: 825 W(no Ar): 600	Total mm H: 825 W(no Ar): 600	Total mm H: 825 W(no Ar): 600	Total mm H: 930 W(no Ar): 490
Backrest H: 400	Backrest H: 400	Backrest H: 400	Backrest H: 400
Packaging data Weight: 6,9 kg Volume: 0,3 m³ Box (L x W x H): 64 x 59 x 80 cm	Packaging data Weight: 7 kg Volume: 0,3 m³ Box (L x W x H): 64 x 59 x 80 cm	Packaging data Weight: 7,7 kg Volume: 0,3 m³ Box (L x W x H): 64 x 59 x 80 cm	Packaging data Weight: 8,3 kg Volume: 0,3 m³ Box (L x W x H): 64 x 59 x 80 cm
Fabric needed (W:140 cm) Fabric: 0,59 m Leather needed: 0,65 m²	Fabric needed (W:140 cm) Fabric: 0,59 m Leather needed: 0,65 m²	Fabric needed (W:140 cm) Fabric: 0,59 m Leather needed: 0,65 m²	Fabric needed (W:140 cm) Fabric: 0,59 m Leather needed: 0,65 m²

Basic equipment ● / options ○		Colour	Order No	Price in €	Price in €	Price in €	Price in €
Seat cover	SG1 - Citadel, Era, Manhattan	See fabric chart		305	453	453	453
	SG2 - Lucia, King, Royal, Medley, Amalfi, Fabric provided, Jot		330	477	477	477	
	SG3 - Fame, Field, Chili, Patina, Remix		355	502	502	502	
Frame	Steel	black	2217	●	—	—	—
		white	2283	○	—	—	—
	Wood	chromed	2324	25 ○	—	—	—
		oak	434	—	●	—	—
Shell	Polyamide	white	3283	●	●	●	●
		black	3217	○	○	○	○
		petrol	3A01	○	○	○	○
		grey-blue	3A02	○	○	○	○
		nude	3A03	○	○	○	○
		mustard	3A04	○	○	○	○
Base	Aluminium	black	563217	—	—	●	—
		white	563283	—	—	○	—
		polished	563304	—	—	87 ○	—
		black	521217	—	—	—	●
		white	521283	—	—	—	○
		polished	521304	—	—	—	87 ○
Castors/Glides	Hard glides for soft floors	black	820	●	●	●	—
	Soft glides for hard floors	black	821	18 ○	18 ○	18 ○	—
	Hard double castors	black ¹	802	—	—	—	●
	Soft double castors	black ¹	801	—	—	—	○
Delivery	Assembled in protective cover	-	904	●	●	●	●
	Assembled in box	-	903	17 ○	17 ○	17 ○	17 ○

Remarks:

¹ Base black or white = castors black, Base polished = castors chrome look.





Order example: standard version with various optional extras

Minimum order information			Options (O)							
SU372	/	5800	/	2324	/	3283	/	820	/	904
Basic model		Fabric		Colour finish/ Metal parts		Colour finish		Castors/ Glides		Delivery

SHUFFLEis1
Lounge chair

Standard:

- Plastic shell with inner padding

 Pyramid base	 Four legs, wood	 Swivel chair with four star base	 Swivel chair with base five-arm
SU376	SU366	SU346	SU356
Seat mm H: 445 W: 490 D: 480	Seat mm H: 445 W: 490 D: 480	Seat mm H: 435 W: 490 D: 480	Seat mm H: 435 - 550 W: 490 D: 480
Total mm H: 830 W(no Ar): 600	Total mm H: 830 W(no Ar): 600	Total mm H: 830 W(no Ar): 600	Total mm H: 830 W(no Ar): 600
Backrest H: 400	Backrest H: 400	Backrest H: 400	Backrest H: 400
Packaging data Weight: 8 kg Volume: 0,3 m³ Box (L x W x H): 64 x 59 x 80 cm	Packaging data Weight: 8,1 kg Volume: 0,3 m³ Box (L x W x H): 64 x 59 x 80 cm	Packaging data Weight: 8,8 kg Volume: 0,3 m³ Box (L x W x H): 64 x 59 x 80 cm	Packaging data Weight: 9,4 kg Volume: 0,3 m³ Box (L x W x H): 64 x 59 x 80 cm
Fabric needed (W:140 cm) Fabric: 1,37 m Leather needed: 1,8 m²	Fabric needed (W:140 cm) Fabric: 1,37 m Leather needed: 1,8 m²	Fabric needed (W:140 cm) Fabric: 1,37 m Leather needed: 1,8 m²	Fabric needed (W:140 cm) Fabric: 1,37 m Leather needed: 1,8 m²

Basic equipment ● / options ○		Colour	Order No	Price in €	Price in €	Price in €	Price in €
Cover inner padding	SG1 - Citadel, Era, Manhattan	See fabric chart		392	541	541	541
	SG2 - Lucia, King, Royal, Medley, Amalfi, Fabric provided, Jot		448	596	596	596	
	SG3 - Fame, Field, Chili, Patina, Remix		503	653	653	653	
Frame	Steel	black	2217	●	—	—	—
		white	2283	○	—	—	—
Frame	Wood	chromed	2324	25 ○	—	—	—
		oak	434	—	●	—	—
Shell	Polyamide	white	3283	●	●	●	●
		black	3217	○	○	○	○
		petrol	3A01	○	○	○	○
		grey-blue	3A02	○	○	○	○
		nude	3A03	○	○	○	○
		mustard	3A04	○	○	○	○
Base	Aluminium	black	563217	—	—	●	—
		white	563283	—	—	○	—
		polished	563304	—	—	87 ○	—
		black	521217	—	—	—	●
		white	521283	—	—	—	○
		polished	521304	—	—	—	87 ○
Castors/Glides	Hard glides for soft floors	black	820	●	●	●	—
	Soft glides for hard floors	black	821	18 ○	18 ○	18 ○	—
	Hard double castors	black ¹	802	—	—	—	●
	Soft double castors	black ¹	801	—	—	—	○
Delivery	Assembled in protective cover	-	904	●	●	●	●
	Assembled in box	-	903	17 ○	17 ○	17 ○	17 ○

Remarks:

¹ Base black or white = castors black, Base polished = castors chrome look.





Order example: standard version with various optional extras

Minimum order information			Options (O)										
S	U	366	/	M	H01	/	21459	/	3283	/	821	/	904
Basic model			Fabric		Colour finish/ Metal parts		Colour finish		Castors/ Glides		Delivery		

SHUFFLEis1
Lounge chair

Standard:

- Plastic shell fully upholstered

 Pyramid base	 Four legs, wood	 Swivel chair with four star base	 Swivel chair with base five-arm
SU374	SU364	SU344	SU354
Seat mm H: 445 W: 490 D: 480 D: 555 Backrest H: 400	Total mm H: 825 W(no Ar): 600 D: 480 D: 555 Backrest H: 400	Seat mm H: 445 W: 490 D: 480 D: 555 Backrest H: 400	Total mm H: 825 W(no Ar): 600 D: 480 D: 555 Backrest H: 400
Packaging data Weight:9,5 kg Volume:0,3 m³ Box (L x W x H): 64 x 59 x 80 cm	Packaging data Weight:9,6 kg Volume:0,3 m³ Box (L x W x H): 64 x 59 x 80 cm	Packaging data Weight:10,9 kg Volume:0,3 m³ Box (L x W x H): 64 x 59 x 80 cm	Packaging data Weight:12,2 kg Volume:0,3 m³ Box (L x W x H): 64 x 59 x 80 cm
Fabric needed (W:140 cm) Fabric:1,64 m Leather needed:2,49 m²	Fabric needed (W:140 cm) Fabric:1,64 m Leather needed:2,49 m²	Fabric needed (W:140 cm) Fabric:1,64 m Leather needed:2,49 m²	Fabric needed (W:140 cm) Fabric:1,64 m Leather needed:2,49 m²

Basic equipment ● / options ○		Colour	Order No	Price in €	Price in €	Price in €	Price in €
Seat and back cover	SG1 - Citadel, Era, Manhattan	See fabric chart		492	640	640	640
	SG2 - Lucia, King, Royal, Medley, Amalfi, Fabric provided, Jot		560	707	707	707	
	SG3 - Fame, Field, Chili, Patina, Remix		627	775	775	775	
Frame	Steel	black	2217	●	—	—	—
		white	2283	○	—	—	—
	Wood	chromed	2324	25 ○	—	—	—
		oak	434	—	●	—	—
Base	Aluminium	black	563217	—	—	●	—
		white	563283	—	—	○	—
		polished	563304	—	—	87 ○	—
		black	521217	—	—	—	●
		white	521283	—	—	—	○
		polished	521304	—	—	—	87 ○
Castors/Glides	Hard glides for soft floors	black	820	●	●	●	—
	Soft glides for hard floors	black	821	18 ○	18 ○	18 ○	—
	Hard double castors	black	802	—	—	—	●
	Soft double castors	black	801	—	—	—	○
Delivery	Assembled in protective cover	-	904	●	●	●	●
	Assembled in box	-	903	17 ○	17 ○	17 ○	17 ○

Remarks:

1 Base black or white = castors black,
Base polished = castors chrome look.

Order example: standard version with various optional extras

Minimum order information				Options (O)																				
S	U	3	4	4	/	5	8	2	4	/	5	6	3	2	8	3	/	8	2	1	/	9	0	4
Basic model				Fabric	Base	Castors/ Glides				Delivery														



MO100



MO100



MONO

Quality:



Warranty (10 year)



Tested safety



BIFMA compliant

Environment:



Bifma e3 level Platin



The Blue Angel
www.blauer-engel.de/uz117



Tested for contaminants



German Design Award
2023 WINNER

Product design ID AID, Sven von Boetticher, Stuttgart

MONOis1
Visitor chairs

Standard:

- Plastic chair
- All-purpose glides



Four legs,
not upholstered,
stacking height¹: 5 pieces

MO100

Seat mm	Total mm
H: 455	H: 835
W: 435	W(no Ar): 480
D: 450	D: 555

Backrest

Packaging data
Weight: 4,28 kg

Box (L x W x H):
65 x 60 x 91 cm

Basic equipment ●/options ○		Colour	Order No	Price in €
Basic price	Not upholstered			135
Shell	Polypropylene	black	3217	●
		white	3283	○
		petrol	3A01	○
		grey-blue	3A02	○
		nude	3A03	○
		mustard	3A04	○
Delivery	Assembled in protective cover	-	904	●
	Assembled in box	-	903	16 ○

Remarks:

- 1 Do not stack chairs with cushions.

Order example: standard version with various optional extras

Minimum order information/Options (O)

M	O	1	0	0	/	3	A	0	1	/	9	0	4
Basic model						Colour finish					Delivery		

MONOis1
Cushion 1



Seat cushion

MO150

Packaging data

Box (L x W x H):
42 x 42 x 6,2cm

Basic equipment ● / options O		Colour	Order No	Price in €
Seat	SG1 - Era	See fabric chart		29
Delivery	Packaged in box	-	903	●

Remarks:

1 This product is not suitable for outdoor areas.

Order example: standard version with various optional extras

Minimum order information Options (O)

MO150 / ER01

Basic model Fabric



F505



F105



F125

Fascino-2

Quality:



Warranty (10 year)

Environment:



Quality produced for the environment

Product design Elzenbeck/Haar, Steinheim

Fascino-2
Conference tables with wood table top

Standard:

- Adjustable glides, black
- Partly assembled ¹ in protective packaging ³

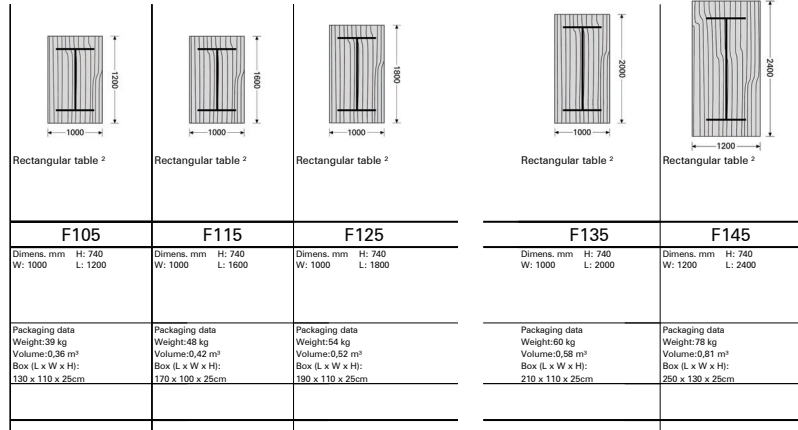

Basic equipment ● / options O		Colour	Order No	Price in €	Price in €	Price in €
Basic price	Basic equipment			1664	1795	1889
Colour finish, metal parts	Steel cross strut generally available in black	black	2217	●	●	●
		brilliant silver	2234	72 O	72 O	72 O
		alu polished	2304	240 O	240 O	240 O
Table top ⁵	MDF, HPL cover 0,8 mm laminate with a 3 mm ABS-edge, in same colour	white grey	42B	●	●	●
		dust grey	42C	O	O	O
		maple	42E	O	O	O
		natural beech	42F	O	O	O
		light oak	42G	O	O	O
		light cherry	42H	O	O	O
		light walnut	42I	O	O	O
		premium white	42A	O	O	O
		MDF, veneer cover, clear varnished genuine wood veneers with a 3 mm wood edge	beech	45050	202 O	233 O
	maple		45150	202 O	233 O	249 O
	oak		45950	202 O	233 O	249 O
	Europ. cherry		45350	463 O	539 O	572 O
	Data box	Sockets (2x230V) + 1xLAN 1xVGA, 3 m power cable	American walnut	45550	463 O	539 O
anodised alum.			60001	890 O	890 O	890 O

Remarks:

1 Traverse and table top assembled, legs attached.

2 Accessories such as power supply and cable outlets can be found in the accessories overview.

3 Please ask your local Interstuhl sales partner for the price of the packaging, assembly, transportation and installation of the tables as well as adjusting the media technology. Please quote "assembly included", the end-users address, contact person and the telephone number on the order. The assembly work should then

be carried out without any interruptions or problems. Please consider the weight of the glass table top.

4 Single table, veneer lengthwise. Special solution veneered crosswise.

5 Top thickness 30 mm; edge design: 13 mm straight, 17 mm bevel.

Order example: standard version with various optional extras

Minimum order information/Options (O)

F135 / 2304 / 45350
 Basic model Colour finish/ Metal parts Decor

Fascino-2
Conference tables with wood table top

Standard:

- Adjustable glides, black
- Partly assembled ¹ in protective packaging ³

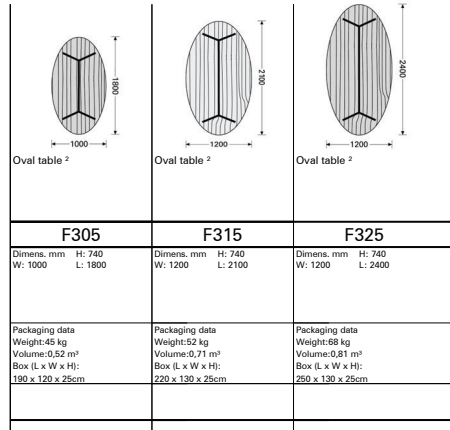

Basic equipment ●/options ○		Colour	Order No	Price in €	Price in €	Price in €
Basic price	Basic equipment			2147	2384	2507
Colour finish, metal parts	Steel cross strut generally available in black	black	2217	●	●	●
		brilliant silver	2234	72 ○	72 ○	72 ○
		alu polished	2304	240 ○	240 ○	240 ○
Table top ⁵	MDF, HPL cover 0,8 mm laminate with a 3 mm ABS-edge, in same colour	white grey	42B	●	●	●
		dust grey	42C	○	○	○
		maple	42E	○	○	○
		natural beech	42F	○	○	○
		light oak	42G	○	○	○
		light cherry	42H	○	○	○
		light walnut	42I	○	○	○
		premium white	42A	○	○	○
	MDF, veneer cover, clear varnished genuine wood veneers with a 3 mm wood edge	beech	45050	333 ○	389 ○	425 ○
		maple	45150	333 ○	389 ○	425 ○
		oak	45950	333 ○	389 ○	425 ○
Europ. cherry		45350	389 ○	905 ○	979 ○	
American walnut		45550	389 ○	905 ○	979 ○	
Data box	Sockets (2x230V) + 1xLAN 1xVGA, 3 m power cable	anodised alum.	60001	890 ○	890 ○	890 ○

Remarks:

1 Traverse and table top assembled, legs attached.

2 Accessories such as power supply and cable outlets can be found in the accessories overview.

3 Please ask your local Interstuhl sales partner for the price of the packaging, assembly, transportation and installation of the tables as well as adjusting the media technology.
Please quote "assembly included", the end-users address, contact person and the telephone number on the order. The assembly work should then

be carried out without any interruptions or problems.
Please consider the weight of the glass table top.

4 Single table, veneer lengthwise.
Special solution veneered crosswise.

5 Top thickness 30 mm; edge design: 13 mm straight, 17 mm bevel.

Order example: standard version with various optional extras

Minimum order information/Options (O)

F	3	2	5	/	2	2	3	4	/	4	5	5	5	0
Basic model					Colour finish/ Metal parts					Decor				

Recommended price in € exclusive of VAT

Fascino-2
Conference tables with wood table top

Standard:

- Adjustable glides, black
- Partly assembled ¹ in protective packaging ³

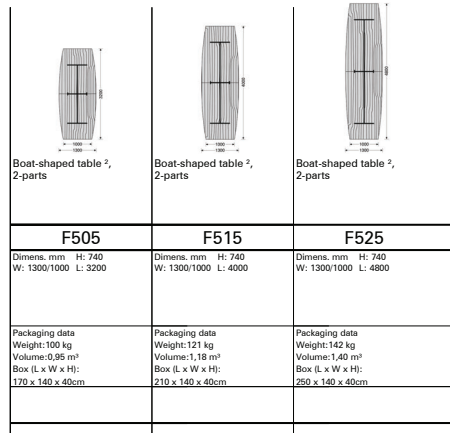

F505	F515	F525
Dimens. mm H: 740 W: 1300/1000 L: 3200	Dimens. mm H: 740 W: 1300/1000 L: 4000	Dimens. mm H: 740 W: 1300/1000 L: 4800
Packaging data Weight: 100 kg Volume: 0,96 m³ Box (L x W x H): 170 x 140 x 40cm	Packaging data Weight: 121 kg Volume: 1,18 m³ Box (L x W x H): 210 x 140 x 40cm	Packaging data Weight: 142 kg Volume: 1,40 m³ Box (L x W x H): 250 x 140 x 40cm

Basic equipment ● / options ○		Colour	Order No	Price in €	Price in €	Price in €
Basic price	Basic equipment			3735	3921	4437
Colour finish, metal parts	Steel cross strut generally available in black	black	2217	●	●	●
		brilliant silver	2234	92 ○	92 ○	92 ○
		alu polished	2304	333 ○	333 ○	333 ○
Table top ⁵	MDF, HPL cover 0,8 mm laminate with a 3 mm ABS-edge, in same colour	white grey	42B	●	●	●
		dust grey	42C	○	○	○
		maple	42E	○	○	○
		natural beech	42F	○	○	○
		light oak	42G	○	○	○
		light cherry	42H	○	○	○
		light walnut	42I	○	○	○
		premium white	42A	○	○	○
	MDF, veneer cover, clear varnished genuine wood veneers with a 3 mm wood edge	beech	45050	499 ○	555 ○	630 ○
		maple	45150	499 ○	555 ○	630 ○
		oak	45950	499 ○	555 ○	630 ○
		Europ. cherry	45350	1183 ○	1329 ○	1480 ○
		American walnut	45550	1183 ○	1329 ○	1480 ○
Data box	Sockets (2x230V) + 1xLAN 1xVGA, 3 m power cable	anodised alum.	60001	1780 ○	1780 ○	1780 ○

Remarks:

1 Traverse and table top assembled, legs attached.

2 Accessories such as power supply and cable outlets can be found in the accessories overview.

3 Please ask your local Interstuhl sales partner for the price of the packaging, assembly, transportation and installation of the tables as well as adjusting the media technology.
Please quote "assembly included", the end-users address, contact person and the telephone number on the order. The assembly work should then

be carried out without any interruptions or problems.
Please consider the weight of the glass table top.

4 Single table, veneer lengthwise.
Special solution veneered crosswise.

5 Top thickness 30 mm; edge design: 13 mm straight, 17 mm bevel.

Order example: standard version with various optional extras

Minimum order information/Options (O)

F	5	0	5	/	2	3	0	4	/	4	5	0	5	0
Basic model					Colour finish/ Metal parts					Decor				

Recommended price in € exclusive of VAT



1132N



9018N



NESTY

Quality:



Warranty (10 year)



Tested safety

Environment:



Quality produced for the environment

Product design Justus Kolberg, Hamburg



German Design Award 2015 NOMINEE



German Design Award 2015 Special Mention

NESTYis3
Folding table, rectangular

Standard:

- Bend steel frame
- Table top (chipboard) 22 mm
- Castors that adjust to different surface heights and can be locked where necessary
- Assembled in box³

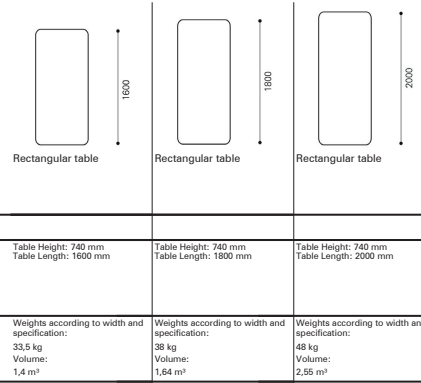
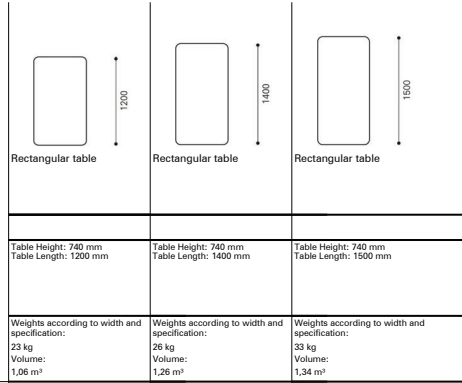

Basic equipment / options		Colour	Order No	Price in €	Price in €	Price in €
Table Depth (mm) ⁴		500	5012N / 806	-	-	-
		600	6012N / 849	6014N / 893	-	-
		700	-	7014N / 965	-	-
		750	-	-	7515N / 1006	-
		800	-	-	-	-
		900	-	-	-	-
		1000	-	-	-	-
	Frame	Cross strut always available in black	black	2217	●	●
brilliant silver			2234	57 ○	57 ○	57 ○
white			2283	57 ○	57 ○	57 ○
chromed			2324	274 ○	274 ○	274 ○
Modesty panel	Acrylic glass	satined white	3217S	284 ○	295 ○	301 ○
	Table top ¹	Melamine, direct coated (DBS), plastic laminate	premium white	41A	●	●
white grey			41B	○	○	○
dust grey			41C	○	○	○
black			41D	○	○	○
maple			41E	24 ○	24 ○	39 ○
natural beech			41F	24 ○	24 ○	39 ○
light oak			41G	24 ○	24 ○	39 ○
light cherry			41H	24 ○	24 ○	39 ○
light walnut			41I	24 ○	24 ○	39 ○
HPL, plastic laminate		premium white	42A	156 ○	156 ○	180 ○
		white grey	42B	156 ○	156 ○	180 ○
		dust grey	42C	156 ○	156 ○	180 ○
		black	42D	156 ○	156 ○	180 ○
		maple	42E	180 ○	180 ○	218 ○
		natural beech	42F	180 ○	180 ○	218 ○
		light oak	42G	180 ○	180 ○	218 ○
		light cherry	42H	180 ○	180 ○	218 ○
		light walnut	42I	180 ○	180 ○	218 ○
Data box ²	Straight edge, ABS (2 mm)	as laminate	..47	●	●	●
	Edge, ABS with rubber protection (R50)	as laminate	..46	164 ○	164 ○	188 ○
	Socket (2x230V), power cable 1.5m	alu anodized	6S1331	245 ○	245 ○	245 ○
	Socket (1x230V) + 2xLAN, power cable 1.5m	alu anodized	6S2331	561 ○	561 ○	561 ○
	Socket (2x230V) + 2xLAN, power cable 1.5m	alu anodized	6S4331	606 ○	606 ○	606 ○
	Socket (2x230V) + 2xLAN + 2xUSB, power cable 1.5m	alu anodized	6S3331	719 ○	719 ○	719 ○
	Socket (2x230V), power cable 3m	alu anodized	6S5331	274 ○	274 ○	274 ○
	Socket (1x230V) + 2xLAN, power cable 3m	alu anodized	6S6331	589 ○	589 ○	589 ○
	Socket (3x230V) + 2xLAN, power cable 3m	alu anodized	6S8331	634 ○	634 ○	634 ○
	Socket (2x230V) + 2xLAN + 2xUSB, power cable 3m	alu anodized	6S7331	748 ○	748 ○	748 ○
Accessories	Table connectors	black plastic	90308	57 ○	57 ○	57 ○

Price in €	Price in €	Price in €
-	-	-
-	-	-
7016N / 1006	-	-
-	-	-
8016N / 1051	8018N / 1079	-
9016N / 1122	9018N / 1151	-
-	1018N / 1198	1020N / 1266
●	●	●
57 ○	57 ○	57 ○
57 ○	57 ○	57 ○
274 ○	274 ○	274 ○
311 ○	325 ○	340 ○
●	●	●
○	○	○
○	○	○
○	○	○
○	○	○
39 ○	51 ○	51 ○
39 ○	51 ○	51 ○
39 ○	51 ○	51 ○
39 ○	51 ○	51 ○
39 ○	51 ○	51 ○
180 ○	212 ○	212 ○
180 ○	212 ○	212 ○
180 ○	212 ○	212 ○
180 ○	212 ○	212 ○
218 ○	262 ○	262 ○
218 ○	262 ○	262 ○
218 ○	262 ○	262 ○
218 ○	262 ○	262 ○
218 ○	262 ○	262 ○
●	●	●
188 ○	209 ○	209 ○
245 ○	245 ○	245 ○
561 ○	561 ○	561 ○
606 ○	606 ○	606 ○
719 ○	719 ○	719 ○
274 ○	274 ○	274 ○
589 ○	589 ○	589 ○
634 ○	634 ○	634 ○
748 ○	748 ○	748 ○
57 ○	57 ○	57 ○

Remarks:
 1 The underside of the table top melamine: as decor
 The underside of the table top HPL: white
 2 Data media always with cable channel
 3 Please get in contact with your sales contact regarding packaging and pricing
 4 Table model 5012N cannot be connected lengthwise

NESTYis3
Folding table, boat-shaped

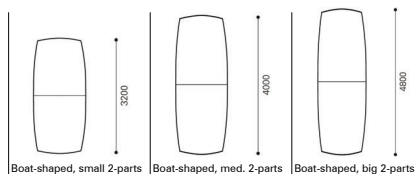

- Standard:
- Bend steel frame
 - Table top (MDF), 25 mm
 - Edge, ABS (2 mm)
 - Castors that adjust to different surface heights and can be locked where necessary
 - Assembled in box⁴

Table Height: 740 mm Table Length: 3200 mm	Table Height: 740 mm Table Length: 4000 mm	Table Height: 740 mm Table Length: 4800 mm
Weights according to width and specification: 38 kg Volume: 2,67 m ³	Weights according to width and specification: 48 kg Volume: 3,3 m ³	Weights according to width and specification: 62 kg Volume: 3,92 m ³

Basic equipment / options		Colour	Order No	Price in €	Price in €	Price in €
Table Depth (mm)		1100/815	1132N / 4185	1140N / 4583	1148N / 5162	
Frame	Cross strut always available in black	black	2217	●	●	●
		brilliant silver	2234	115 ○	115 ○	115 ○
		white	2283	115 ○	115 ○	115 ○
		chromed	2324	549 ○	549 ○	549 ○
Table top ¹	HPL, plastic laminate	premium white	42A	●	●	●
		white grey	42B	○	○	○
		dust grey	42C	○	○	○
		black	42D	○	○	○
		maple	42E	242 ○	270 ○	299 ○
		natural beech	42F	242 ○	270 ○	299 ○
		light oak	42G	242 ○	270 ○	299 ○
		light cherry	42H	242 ○	270 ○	299 ○
		light walnut	42I	242 ○	270 ○	299 ○
Data box ^{2,3}	Socket (2x230V), power cable 1.5m	alu anodized	6S1331	491 ○	491 ○	491 ○
	Socket (1x230V) + 2xLAN, power cable 1.5m	alu anodized	6S2331	1121 ○	1121 ○	1121 ○
	Socket (3x230V) + 2xLAN, power cable 1.5m	alu anodized	6S4331	1212 ○	1212 ○	1212 ○
	Socket (2x230V) + 2xLAN + 2xUSB, power cable 1.5m	alu anodized	6S3331	1439 ○	1439 ○	1439 ○
	Socket (2x230V), power cable 3m	alu anodized	6S5331	547 ○	547 ○	547 ○
	Socket (1x230V) + 2xLAN, power cable 3m	alu anodized	6S6331	1178 ○	1178 ○	1178 ○
	Socket (3x230V) + 2xLAN, power cable 3m	alu anodized	6S8331	1269 ○	1269 ○	1269 ○
Socket (2x230V) + 2xLAN + 2xUSB, power cable 3m	alu anodized	6S7331	1495 ○	1495 ○	1495 ○	







- Remarks:
- ¹ The underside of the table top always as decor.
 - ² 1132N, 1140N and 1148N always come with two data connection fields.
 - ³ Data media always with cable channel.
 - ⁴ Please get in contact with your sales contact regarding packaging and pricing

Order example: standard version with various optional extras

Minimum order information/Options (O)

1	1	3	2	N	/	2	2	3	4	/	4	2	E	/	6	S	2	3	3	1
Basic model						Base/ Base					Table Top			Elektrifizierung						

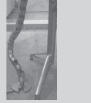
TABLE EQUIPMENT

Accessories			Order No.	Fascino-2	Silver	VLEGS ⁵³	Price in €
Electrical box	*Axial* swivelling, with lid, silver		922	x		x	861,-
	Aluminium		K01..		x		7.628,-
Cable channel	Aluminium		911	x		x	95,-
Cable grommet	Stainless steel		924	x		x	85,-
	Polypropylene		925	x		x	47,-
Cable duct	Vertical including foot plate		926	x		x	110,-
	Cable channel for Silver conference tables, vertical		7KA		x		542,-
Table transport trolley			T1T1			x	886,-



Order accessories always directly with the respective table model. Positioning and way of connecting on request.

Order example: standard table version with optional extras



F105 / 45150 / 922
Accessories (e.g. *Axial*)

Subject to change!

CHAIR EQUIPMENT

Accessories	Model No.	Goal (Cantilever frame)	Hero / Goal-Air	VLEGS ⁵³	SHUFFLE ⁵¹	Price in €	
Chair transport trolley	TR07	-	x	-	-	1.003,-	
	TR09	-	x	-	-	-	
	S1T1		-	-	x	-	347,-
	S1T2		-	-	x	x	1.158,-
S1T3		-	-	x	x	2.447,-	

Accessories	Collection	Order No.	Price in €
Seat and series numbering	VLEGS ⁵³	upon request	39,-

Accessories	Collection	Order No.	Price in €	
Coat hanger	Hero		...06	75,-
	AIM ⁵¹ , EVERY ⁵¹ , JOYCE ⁵³ und VINTAGE ⁵⁵		3217K	
for other collections on request				

Order coat hangers always directly with the respective chair model

Order example: standard chair version with various optional extras

Hero:
172H / 5800 - 8010 / 521234 / 610 / 709 / 801 / 903 / 06
Accessories (coat hanger)

AIM, EVERY, JOYCE und VINTAGE:
1S01 / 5800 / 3217K / 521304 / 610 / 703 / 802 / 902
Plastic parts & coat hanger

Subject to change!

CASTORS

The rule of thumb here is:
 Hard floors - soft castors;
 soft floors - hard castors.
 For safety reasons, the EN applies to office swivel chairs;
 it states that unoccupied swivel chairs may not roll away.
 The rolling behaviour is heavily influenced by the composition of the floor. It is therefore necessary to coordinate the castors with the type of floor. In proper use, our castors deliver the necessary roll resistance as specified by DIN EN 1335.
 Make the right choice!

Castors designation	Colour	Order No.	Price in €	Champ / AirPac / Goel-Air / AIM [®] / JOYCE [®] / EVERY [®] / PURE [®] / BUDDY [®]	Hero / Goel	TWENTYFOUR [®]	VINTAGE [®]	NESTY [®]	KINETICISS (Perch)	KINETICISS (Standing table)
Hard double castors for soft floors	black	4042	63,-							
		4002	45,-	●	●					
		4052	58,-							
		4064	58,-					●		
Soft double castors for hard floors	black	4043	80,-			●				
		4003	45,-	●	●					
		4051	58,-					●		
		4063	58,-						●	
Glides for hard floors	black	4040	58,-	●	●					
		4058	58,-				●			
		4047	24,-						●	
		4049	24,-							●
	brilliant silver	4059	63,-				●			
	white	4060	63,-				●			
	polished	4061	88,-				●			
	chromed	4062	102,-				●			
Glides for soft floors	black	3963	58,-	●	●					
		4027	58,-	● ¹	● ¹					
		4053	58,-				●			
		4046	24,-						●	
	4048	24,-							●	
	brilliant silver	4054	63,-				●			
	white	4055	63,-				●			
	polished	4056	88,-				●			
chromed	4057	102,-				●				
MOS electrically conducting castors - Due to their material composition, these castors are only available in black.										
Hard double castors for soft floors	black	4036	71,-		●					
Soft double castors for hard floors	black	4037	71,-		●					

- = possible choice of castors and glides for each model family
- ¹ = Counter chairs

Remark:
 All listed castors possess brakes and comply with DIN 69131 and DIN-EN 12529.
 Other castors are available from our customer service department.

INSTRUCTIONS FOR USE: CASTORS / FLOORS

PARQUET FLOORS

Should not be walked on with wet or dirty outdoor shoes. Dust, stones, grains of sand, etc. can cause serious damage, particularly if these are pressed into the floor through loads, e.g. from shoes, castors of swivel chairs (some of these particles may be pressed into soft castors).

STONE FLOORS

Spilling drinks (cola, alcohol, etc.) and treating these floors with acidic cleaning agents leads to an etching and disintegration of the lime shares contained in the stone. This in turn leads to damage following additional pressure loads from castors.

LINOLEUM

Contains linseed oil, i.e. a fatty acid, as a raw material component. If basic cleaning is carried out with an alkaline cleaner (pH value > 10.5) the fatty acids together with the alkalines can cause a so-called saponification process. This produces soap that withdraws the main constituent of linoleum – the fatty acid – particularly in areas where the floor is subject to heavy loads (heavy through traffic, castors of swivel chairs, etc.) Strong discolorations, heavy wear, cracks and breaks may occur.

We cannot be held liable for any claims for compensation resulting from this type of use.

CARE INSTRUCTIONS FOR THE COVER FABRICS AND TABLE TOPS

To ensure that you enjoy your Interstuhl product as long as possible, please note the following care instructions:

Fabric

Regular cleaning maintenance: Please clean the upholstery at least once a month by using a vacuum cleaner with nozzle at low vacuuming power (500 watt) or brush in the direction of the fabric by using a soft brush. We would recommend using a professional cleaning company for linen or silk due to their delicate nature.

Stain Removal

Stains are best removed by using a fabric cleaner e.g. PURATEX or an intense cleaner from LCK. Please test the colour fastness on a hidden section of the upholstery first. Hereafter, please follow the cleaning product instructions. Please do not apply the cleaning product directly onto the upholstery, use a soft cloth. Please clean stains as soon as possible and always from the outside to the inside. In order to avoid any residual marks, please clean the entire area after this. Dab off moist stains with an absorbent cloth. We would like to ask you not to apply a lot of pressure when cleaning. The rubbing might change the surface of the upholstery.

For help with stubborn stains or marks, please visit our website (www.interstuhl.com/care) or contact our customer service team directly.

Leather

Leather is a natural product; it is unique similarly to the fingerprint of a person. Each leather hide has its individual character which is stretched for furniture. In contrast to fabric, leather is not as stretchy as fabric when used permanently or frequently. Therefore, the tension decreases and typically, wrinkles occur. Colour variations may also occur because the leather absorbs the colour differently. Our employees do their

very best to avoid colour variations. Please refer to "Manufacturing and Quality Regulations" for further information.

General Remarks

Please do not use any cleaning products containing solvent, shoe polishing or beeswax. Do not leave leather close to the heating. Please use special leather cleaning products only, e.g. KERALUX. KERALUX products from LCK were developed by tanneries and upholstery companies and therefore, fulfil high-quality furniture leather requirements. Please see www.interstuhl.com/care.

Maintenance

It is recommended to wipe the leather once a week in order to remove dust from pores. Every half year, please clean the leather thoroughly. Please use a product similar to KERLUX leather cleaning product set A or cleaning product set P (for Semi-Aniline leather or coated leather). Firstly, the leather is cleaned thoroughly, thereafter, moisturiser is applied to prevent the leather drying out.

Stain Removals

Leather stains can be removed with KERALUX intense cleaner. For special stain remover e.g. suitable for ballpoint-pen stains, please refer to www.interstuhl.com/care.

Synthetic leather

Apart from its appearance, synthetic leather does not have any characteristics in common with real leather. For this reason, it needs to be taken care of differently. Unlike real leather, which needs care and cleaning, synthetic leather needs cleaning only. This is due to its surface

coating (PVC, PC) which does not require any care substances.

Regular Maintenance

Please use a moist cloth in order to dust off the synthetic leather.

Cleaning

In order to remove stains, please use special synthetic leather cleaner from LCK. Please test at a hidden section first.

Protection

For light synthetic leather it is recommended especially to use an intensive protector from LCK. These products help to prevent the build-up of dirt in areas of abrasion caused by jeans for example.

Veneer

Maintenance: Please dust the veneer regularly using a dry, soft and lint-free cloth. Depending on the wood, please use special wood care products like SILVAPUR care set by LCK for varnished or oiled/waxed woods.

Laminates

Maintenance: Please dust the veneer using a dry, soft and lint-free cloth. Please use standard laminate cleaning products for stain removal.

Our customer service team is happy to answer any questions you may have with regard to furniture care. Alternatively, you can visit the furniture care page on our website at www.interstuhl.com/care.



GENERAL TERMS OF BUSINESS

1. General information

1.1 Our terms and conditions of payment and sale apply to all goods and services. Other conditions, e.g. customer terms of purchase, will only then become components of the contract if this is expressly agreed in writing. If the customer is a merchant or a legal entity under public law or a special fund under public law, our terms and conditions of payment and sale apply to all future transactions.

2. Contents of the contract

2.1 All information in catalogues, price lists or order proposals is non-binding. Only the terms agreed for a specific order are binding. Terms for an order are only considered binding once we have accepted the order from the customer (order confirmation). Suggestions we have made regarding an order only become binding after the order has been placed and confirmed.

2.2 Custom-made products are items that are not mass-produced or are not included in the price lists. This also applies to colour schemes.

2.3 The formation of a contract is subject to correct self-delivery. This does not apply if we are responsible for the missing or incorrect delivery, particularly if we have not carried out a congruent hedging transaction. We shall inform the customer immediately of any unavailable items and will refund any payments made without delay.

3. Prices

3.1 We shall quote our prices to merchants, legal entities under public law and public law special funds as gross prices minus discounts, plus the applicable statutory value-added tax, excluding packaging, transport costs, assembly and insurance. If there are more than four months between the formation of the contract and the delivery date, we are entitled to charge the price valid upon delivery.

3.2 For entrepreneurs and in the case of successive delivery contracts, we charge the current price valid on the day of delivery.

4. Transfer of risk

4.1 Our deliveries are carried out via FCA, Tiering – INCOTERMS 2020, insofar as no other arrangement has been agreed upon.

4.2 If shipment is delayed as a result of circumstances for which the customer is responsible, the risk is transferred to the customer from the day on which the delivery is ready to be shipped. In this case, we are entitled to store goods at the customer's expense and risk at our discretion and to request payment of the agreed price.

4.3 Customer claims as a result of a defect in the delivery must be based on immediate examination of the goods and notification of the defect after delivery – within seven working days at the latest – in the case of a recognisable defect. In the case of an invisible defect, notification must take place within this same period after the defect is discovered.

5. Delivery

5.1 If a date or time period is stated in or can be determined from the contractual documents for deliveries, e.g. a specific calendar week, this is when the delivery is due. The customer must ensure that the delivery can be received at least during normal business hours. For lead times or deadlines that must not be exceeded under any circumstances (fixed deadlines), this must be expressly agreed in a way that cannot be misconstrued.

5.2 If, due to force majeure, operational disruptions, strikes, lockouts, war, disasters and/or official interventions or orders, we are prevented from making the delivery and/or providing the service, we are entitled either to withdraw from the contract or to provide the agreed service as soon as possible after these obstacles are removed. There will be no compensation for damages in these cases. We reserve the right to not make a delivery where the credit rating is insufficient or not provided.

5.3 The customer shall be responsible for bringing the goods to the place of use and for

unpacking and setting them up. However, if the goods are to be conveyed by us to the customer, we are entitled to request payment for the work involved in providing this additional service.

5.4 Call orders are limited to a maximum of one year; during this time all deliveries must be accepted; the minimum recall period is one month.

6. Payments

6.1 Unless otherwise agreed, payments are due immediately and must be paid 30 days after the invoice date at the latest, without any deductions. Payment terms do not postpone the due date, but rather the latest possible payment date according to the calendar. If the payment is received within 10 days of the invoice date, we shall apply a 2% discount.

6.2 Bills of exchange and cheques will only be accepted if agreed upon, and only as conditional payment. If a cheque or bill of exchange is lost, we are not obliged to continue seeking payment from the document. Discount and bill of exchange charges and other costs are to be paid by our customer and must be settled in advance. Cheques will not be accepted as cash payment.

6.3 We have legal claims in the event of late payment.

6.4 The customer will only be entitled to offset if their counterclaim has been legally established or is undisputed. This ban on offsetting does not apply to counterclaims due to a defect based on the same contractual relationship as our claim. The customer is only entitled to exercise a right of retention insofar as their counterclaim is based on the same contractual relationship.

7. Retention of title

7.1 We retain the title to the goods until full payment has been received for all claims, including future claims, arising from the entire business relationship, including all ancillary claims. If there is an open account, the retained title acts as security for balance claims.

7.2 The customer is permitted to resell goods

owned or co-owned by us in the ordinary course of business. The customer hereby assigns to us all claims against their customers arising from the resale; we hereby receive this assignment.

7.3 The customer remains authorised to collect claims assigned to us. The customer must immediately inform us of any third-party access to our retained-ownership goods or to a claim assigned to us, particularly any attachments. The costs of any required interventions are payable by the customer. 7.4 We undertake to release goods to which the title has been retained, as well as assigned claims in accordance with Section 7.2, if the realisable value of the collateral exceeds 110% of the secured claim. This release shall be carried out via transfer of ownership or reassignment.

8. Material defects

8.1 If the goods delivered are defective, we will choose whether to remedy the defects or send a replacement.

8.2 Defects do not include technologically justified differences in dimensions or shape, laminate colour, material colour, or the colour and texture of the real wood veneer.

8.3 The customer undertakes to allow us access to the goods about which a complaint is being raised.

8.4 If deliveries are to be based on drawings or other information provided by the customer, we shall follow these instructions if they are technically feasible. We will not check whether they are feasible until a special order is placed.

8.5 The customer assumes liability that their commissioned order does not infringe upon the rights of any third parties. The customer's statutory rights of recourse against us only exist insofar as the customer has not entered into any agreements with their own customer which go beyond the statutory claims for defects.

9. Other claims, liability

9.1 Insofar as this is not contradicted below, there may be no other, ongoing claims by the

customer against us. This particularly applies to claims to compensation due to breach of contractual duties and tort. We are therefore not liable for damages not incurred to the delivered goods themselves. Most notably, we are not liable for loss of profits or other damage to the customer's assets.

9.2 The above limitations of liability do not apply in the event of malicious intent, gross negligence on the part of our legal representatives or senior employees or culpable breach of material contractual obligations. In the event of culpable breach of material contractual obligations, we are only liable for typical, reasonably foreseeable damage, except in the case of malicious intent or gross negligence by our legal representatives or senior employees.

9.3 These limitations of liability also do not apply in the event that liability is assumed under the Product Liability Act for personal injury or material damage to objects for private use in the event of defects in the delivered goods. It shall also not apply in the event of loss of life, physical injury or damage to health and in the event that a guaranteed quality is lacking.

9.4 Insofar as we have no or limited liability, this also applies for the personal liability of our employees, workers, colleagues, legal representatives and subcontractors.

9.5 This does not affect the statutory regulations regarding burden of proof.

10. Limitation period on claims for defects and damages

10.1 The limitation period for customer claims due to defective goods is one year. This does not apply if a longer period is provided for in accordance with Section 438(1) No. 2 (buildings, objects used in buildings), Section 479(1) (recourse claims) or Section 634(1) No. 2 (construction defects) of the German Civil Code. This also does not apply to claims to compensation which are based on compensation for bodily injury or damage to health, or on malicious intent or gross negligence on our part

or on the part of our subcontractors.

10.2 The limitation period for customer compensation claims which do not relate to defective goods is one year. This does not affect the limitation period of claims due to malicious intent or gross negligence as well as bodily injury or damage to health and due to the Product Liability Act.

11. Documents and samples

11.1 We reserve all intellectual property rights and copyrights for cost proposals, drawings, images, sketches and other documents and samples; the documents must be sent back to us upon request and must not be passed on to third parties, even as a copy.

11.2 Samples must be returned to us or purchased within a month unless otherwise agreed. Samples for custom-made products must be purchased by the customer and may not be exchanged.

12. Place of jurisdiction, applicable law

12.1 It is hereby agreed that German law will apply.

12.2 For all legal disputes, including in the context of processes for bills of exchange or cheques, our head office is the place of jurisdiction if the customer is a merchant, a legal entity under public law or a special fund under public law. We are also entitled to sue at the customer's place of business.

13. Data protection

13.1. The personal and company-related data of our customers is stored and processed in compliance with the EU Data Protection Regulation (EU-DSGVO).

TERMS OF SALE AND DELIVERY

This price list is valid from 1st January 2023. The publication of this list renders all previous price lists invalid. The delivery will be carried out in accordance with our General Terms and Conditions, about which you have been informed. Models from previous ranges and past price lists that are no longer listed are only available on request. The stated prices are non-binding recommended prices in € plus the applicable VAT.

Terms and conditions of supply

Our deliveries are carried out via FCA, Tübingen – INCOTERMS 2020, insofar as no other arrangement has been agreed upon.

Changes to orders

Changes to orders and postponement of delivery dates can only be taken into consideration if they are confirmed by us in writing. We reserve the right to add a surcharge in these cases. If we have to store products due to the postponement of a delivery, we will charge €1.00 per product per calendar week. Order alterations must be made at least 10 working days before the confirmed delivery date. (For tables: 5 working days after the order is received).

General information

Measurements

The measurements are determined according to EN 1335. The stated measurements are approximate values. Tolerances are permitted.

Colour differences

Colour deviations in upholstery fabrics or décors are due to production or, in the case of leather and wood, to natural causes. No claims may be made for slight deviations, particularly in the event of subsequent deliveries.

Orders

Minimum order information: Always state the basic model and the number of the cover. If the seat and backrest are to have different covers, please specify the seat first and then the backrest. Example: 152G/5800 – 5824. Options: If you want a different option than the standard one (the standard option is indicated by black dots), please state the corresponding order

number after the minimum order details. Options example: 172H/CI01 – 8010/601/703. Please use our order forms.

Castors and glides

All chairs/armchairs are fitted with castors for carpeted floors as standard (in accordance with DIN EN 12529). If the chairs are to be used on hard floors, please select the option "soft castors" or "felt glides for hard floors" when ordering the chairs. We cannot be held liable for the use of incorrect castors or glides.

Custom-made products

Interstuhl can only provide its exceptionally reasonable price-performance ratio by using rational production. Please clarify any special requests with us. We will add a surcharge here depending on the design required. The cover materials provided will be invoiced in price group 2 with a minimum order quantity of 10 items per model and order. When using customer fabrics

or customer leather, the usability of the cover materials must be checked using the provided sample before the order can be accepted. We cannot be held liable for the quality of the material delivered to us, nor for its processing or for any defects that subsequently occur. We generally assume a minimum width of 1.40 m for cover fabrics provided. It is essential that you provide us with processing instructions (particularly the direction of the upholstery as well as the front and back). We will gladly send you a form to fill in to this end.

The order shall only be entered and confirmed after the cover materials have been checked for usability.

Return and disposal

Interstuhl will be happy to assist, upon request, in disposing of products in an environmentally friendly manner. Any transport costs that may arise as a result of this are payable by the customer.

Interstuhl Büromöbel GmbH & Co. KG ("INTERSTUHL") offers a warranty for the guaranteed products defined here, subject to the following conditions.

The warranty applies in addition to and without prejudice to any legal or contractual entitlements and rights that the claimant has.

Guaranteed products are all products by INTERSTUHL with the exception of electronic/digital products such as sensors. The warranty applies to guaranteed products used in the country in which this price list is valid. The only person entitled to make claims on this warranty is the owner of the guaranteed product. Other persons do not have the right to make claims on this warranty. The warranty covers situations in which a guaranteed product suffers from a defect within the warranty period and a warranty exclusion does not apply. INTERSTUHL offers a long-term warranty of ten years (of which the first three years comprise a full warranty) from the date of production 1st February 2016, which can be found on a label on the underside of the product. During the full warranty period, all spare parts will be supplied free of charge including assumption of packaging costs. INTERSTUHL reserves the right to carry out repairs during the full warranty period, at the factory or on-site, or via and at the premises of authorised dealers and partners. Any costs incurred for unjustified warranty repairs will be invoiced. After expiry of the full warranty period, INTERSTUHL supplies all spare parts free of charge from the fourth to the tenth year as part of the long-term warranty. Costs for the duration of warranty work carried out at the dealer, the end customer or in the plant shall be invoiced, including the costs for transit times. These will be offered on request and in-

voiced separately. Wearing parts such as cover materials, foam parts (integral foams), upholstery, castors, surfaces of frames/bases and tables, edges and edge strips of tables are excluded from the long-term warranty.

Claims cannot be made on the warranty if the defect has been caused by the guaranteed product being installed, put into operation or transported incorrectly by or on behalf of the claimant; the guaranteed product being modified incorrectly (e.g. attempts at repair) by the claimant or by third parties that have not been authorised by INTERSTUHL; failure to observe safety regulations, operating instructions and installation standards; force majeure (storms, lightning strike, overvoltage, fire, etc.); The defect has been caused by use of a cleaning agent or care product not recommended by INTERSTUHL.

Only cleaning agents and care products recommended by INTERSTUHL may be used for maintaining and cleaning your item of Interstuhl furniture. (www.interstuhl.com/care) The defect has been caused by normal wear and tear, natural deterioration or environmental factors; The defect has been caused by the claimant requesting a deliberate variation on the standard product or by any materials made available by the claimant. The warranty periods apply for conventional industrial use, i.e. eight hours per day, 220 working days per year. In cases of multiple-shift operation, or use 24-hours per day throughout the year, the warranty period shall be reduced accordingly. If a warranty claim is made, INTERSTUHL shall remedy the defect – at its own discretion and at its own expense – by having the guaranteed product repaired by INTERSTUHL, a retailer or the claimant, or by supplying new or reconditioned parts. Spare parts shall be the property of INTERSTUHL. If an inspection by INTERSTUHL reveals that a warranty claim cannot be made,

and that the claimant could have known this, INTERSTUHL may charge a service fee for inspection and handling in accordance with its currently valid price list. The warranty period shall not be restarted or limited by acceptance of a warranty claim.

To make a claim on the warranty, INTERSTUHL requires the following information: Description of the defect, model name, model number, order confirmation number, delivery note or invoice document (if applicable). This information about the chair and table models can be found on the label on the underside of every product. If this information is not provided, INTERSTUHL may refuse to process the warranty claim. The warranty claim can be processed more quickly and easily if INTERSTUHL is sent a photograph and/or a short video together with the information stated above. A claim can be made on the warranty by sending this information to:

Interstuhl Büromöbel GmbH & Co. KG
Brühlstraße 21,
72469 Meßstetten-Tieringen, Germany
Fax +49 (0) 7436 871 88709
E-mail: info@interstuhl.de

The guaranteed product must be sent to INTERSTUHL in its original packaging or packaging of equal quality. This warranty is subject to German law. If the purchaser is a merchant as defined in the German Commercial Code, a legal entity under public law or a special fund under public law, the registered office of INTERSTUHL in Meßstetten-Tieringen shall be the exclusive place of jurisdiction – including on an international level – for all disputes arising from the warranty, either directly or indirectly.

As of: 05/2019

WORKMANSHIP AND QUALITY STANDARDS

for all types of leather

These characteristics do not indicate any deterioration in quality; they prove the authenticity of the leather and demonstrate the genuine sturdiness of the natural raw material.

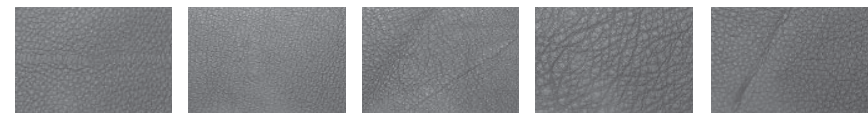

Pigmented

Subtle insect bites

Veins

Textural differences

Creases

COVERS FOR INDIVIDUAL PRODUCT FAMILIES

Group	Fabric	Silver	VINTAGE ^{BS}	Champ	AirRad	Hero	PURE ^{BS}	JOYCE ^{BS}	GoalAIR	Goal	¹ AIM ^{BS1}	¹ EVERY ^{BS1}	TWENTYFOUR ^{BS}	HUB-Armchair, Sofa, Corner Sofa, Bench, Stool, Swing, Cushion	HUB-Partition wall-modules, Media walls, Middle walls, Backwalls for Soft Conference-Modules, Photobooths	TANGRAM ^{BS}	LEMON ^{BS}	LIME ^{BS}	KINETIC ^{BS}	BUDDY ^{BS}	VLEGS ^{BS} - Visitor chairs & benches	VLEGS ^{BS} - Upholstered benches	SHUFFLE ^{BS1}
SG1	Citadel						o	x	x	o	x	x				x				x	x	x	x
	Era						x	x	x	x	x	x		x	x	x	x			x	x	x	x
	Manhattan						x	x	x	x	x	x		x	x					x	x	x	x
	Strick Seat								x ²														
SG2	Lucia	x	x	x	x	x	x	x	x	x	x	x		x	x	x	x	x	x	x	x	x	x
	King	x	x	x	x	x	x	x	x	x	x	x		x		x	x	x	x	x	x	x	
	Royal			x	x	x	x	x	x	x	x	x		x	x					x	x	x	x
	Medley			x	x	x	x	x	x	x	x	x		x	x	x	x	x	x	x	x	x	x
	Amalfi			x	x	x	x	x	x	x	x	x		x		x	x	x	x	x	x	x	x
SG3	Jet	x	x	x	x	x	x	x	x	x	x	x		x	x	x	x	x	x	x	x	x	x
	Fame	x	x	x	x	x	x	x	x	x	x	x		x	x	x	x	x	x	x	x	x	x
	Field	x	x	x	x	o	x	x	o	x	x	x		x	x	x	x	x	o			x	x
	Climatex Ultra								x			x											
	Patina	x	x	x	x	x	x	x	x	x	x	x		x	x	x	x	x	x			x	x
	Chili	x	x	x	x	x	x	x	x	x	x	x		x	x	x	x	x	x			x	x
HP4	Remix	x	x	x	x	x	x	x	x	x	x	x		x		x	x	x	x			x	x
	Synergy	x	x	x	x	x	x	x	x	x	x	x		x	x	x	x	x				x	
	PLxxx			x	x	x	x	x	x	x	x	x		x		x							
	Rime			x	x	x	x	x	x	x	x	x		x	x	x	x	x					x
LG6	Steelcut Trio			x	x	x	x	x	x	x	x	x		x	x	x	x						x
	Nappa leather			x	x	x	o	x	x	x	o												x
LG7	Semi-Aniline leather			x	x	x	x	x			x			x		x	x	x				x	x
Two upholstery colours within a fabric group for seat and back covers lead to an upcharge in €			20			20	20	20	20	20							20						

o = increases wrinkling and fall of folds

Remarks:

¹ For the collections EVERY, BUDDY and AIM with Chillback and upholstered backrest please take the considered fabric only from the collection pages.

² Only for JOYCE mesh and Softback models.

FABRIC COVERS: TECHNICAL DATA AND PRICES

Group	Fabric	Material	Weight	Width in cm	Abrasion EN ISO 12947-2	Pilling values (1-5) EN ISO 12946-2	Resistance to rubbing (1-5) EN ISO 105X-12	Lightfastness 2 (1-8) EN ISO 105B 02	Fire prevention standards							Price in €
									D	A	CH	F	GB	NL	ES	
SG1	Citadel	100% Polypropylen FR	320 g/m ²	140	≥30,000	3-4	4	6	1:2,3	1:2	1:2	1:2	1:2,4	1:2,3	1:2,3	54,-
	Era ²	100% Polyester	448 g/m ²	140	≥100,000	4-5	4	5	1:2	1:2	1:2	1:2	1:2,4	1:2	1:2	54,-
	Manhattan ²	100% recycled Polyester	405 g/m ²	140	≥50000	4-5	4	6	1:2	1:2	1:2	1:2	1:2,4	1:2	1:2	54,-
SG2	Lucia ²	100% Polyester	400 g/m ²	140	≥100,000	3-4	4	6	1:2	1:2	1:2	1:2	1:2,4	1:2	1:2	103,-
	King (L Eleast) ²	100% Polyester (Trevira CS)	365 g/m ²	140	70.000	5	4-5	6	1:2,3	1:2	1:2	1:2,3	1:2,3,4	1:2,3,4	1:2,3	103,-
	Royal	100% Polyester	490 g/m ²	150	≥100,000	4-5	4	5	1:2	1:2	1:2	1:2	1:2,4	1:2	1:2	103,-
	Medley ²	100% Polyester	510 g/m ²	140	75.000	4	4-5	5-7	1:2	1:2	1:2	1:2	1:2	1:2	1:2	103,-
	Amalfi	Synthetic leather 86% PVC 14% Polyester	910 g/m ²	140	≥250,000		5	6	1:2,4	1:2	1:2	1:2,4	1:2	1:2	1:2,4	103,-
	Jet ²	100% Polyester	365 g/m ²	140	65.000	5	4-5	5-8	1:2,3	1:2	1:2	1:2,3	1:2,4	1:2,3	1:2,3	103,-
SG3	Fame ²	95% New wool 5% Polyamide	630 g/m ²	140	200.000	4	4-5	5-7	1:2	1:2	1:2	1:2	1:2,3	1:2	1:2	132,-
	Field ²	100% Polyester (Trevira CS)	450 g/m ²	140	100.000	4-5	4-5	5-7	1:2,3	1:2	1:2	1:2	1:2,3	1:2,3	1:2,3	132,-
	Climatex Ultra ²	72% Cradura TM 16% Certified virgin wool 12% Redesigning Lenzing FR TM	437 g/m ²	141	> 500.000	4	4-5	6-7	1:2	1:2	1:2	1:2	1:2	1:2	1:2	132,-
	Patina	69% Wool 22% Flax 8% Polyamide 1% Viskose	462 g/m ²	140	≥100,000	5	3-4	5	1:2	1:2	1:2	1:2	1:2,3,4	1:2	1:2	132,-
	Chili ²	100% recycled Polyester FR	470 g/m ²	140	60.000	4-5	4-5	5-8	1:2,3	1:2	1:2	1:2	1:2,3,4	1:2,3	1:2,3	132,-
	Remix ²	90% New wool worsted 10% Worsted	420 g/m ²	140	100.000	4	4-5	5-7	1:2	1:2	1:2	1:2	1:2,3	1:2	1:2	132,-
HP4	Synergy ²	95% New wool 5% Polyamide	560 g/m ²	140	≥100,000	3	4	5	1:2	1:2	1:2	1:2	1:2,4	1:2	1:2	153,-
	Puux ^{1,2}	Synthetic leather (100% Polyurethane)	740 g/m ²	145	90.000		4-5	6-7	1:2	1:2	1:2	1:2	1:2,3	1:2	1:2	153,-
	Rime ²	90% New wool worsted 10% Nylon	580 g/m ²	140	100.000	4	4-5	5-6	1:2,4	1:2	1:2	1:2	1:2	1:2	1:2,4	153,-
	Steelcut Trio ²	90% New wool worsted 10% Nylon	770 g/m ²	140	100.000	4	4-5	5-7	1:2,4	1:2	1:2	1:2	1:2,3	1:2	1:2,4	153,-
LG6	Nappa leather ³	dye-through leather quality				≥4	≥5	1:2	1:2	1:2	1:2	1:2	1:2	1:2	1:2	190,-
LG7	Semi-Aniline leather ³	Full-grain leather with a light finish				≥4	≥5	1:2	1:2	1:2	1:2	1:2	1:2	1:2	1:2	445,-

¹ BT on request.

² Materials have "Oko-Tex/EU-Flower" certification. Therefore, the models comply with "Tested for harmful substances" certification.

³ Leather certified with the "Blue Angel". Therefore, the models comply with "Tested for harmful substances" certification.

Fire-safety standards

D	2	EN	1021 part 1	CH	1	EN	1021 part 1
	3	DIN	4102 part 1; B1		2	EN	1021 part 2
	4	DIN	4102 part 1; B2	F	1	EN	1021 part 1
A	1	EN	1021 part 1		2	EN	1021 part 2
	2	EN	1021 part 2		3	NF P 92501-7; M1	
					4	NF P 92503; M2	

GB	1	EN	1021 part 1	NL	1	EN	1021 part 1
	2	EN	1021 part 2		2	EN	1021 part 2
	3	BS	5852 part II		3	DIN	4102 part 1; B1
	4	BS 7176	Low Hazard		4	NF P 92501-7; M1	

ES	1	EN	1021 part 1		1	EN	1051:2
	2	EN	1021 part 2		2	EN	1058:2
	3	DIN	4102 part 1; B1		3	DIN	4102 part 1; B1
	4	DIN	4102 part 1; B2		4	NF P 92501-7; M1	

¹ EN ISO 1051:2
² EN ISO 1058:2

FABRIC COVERS

Fabric group 1

Citadel

100% Polypropylene FR
320 g/rm

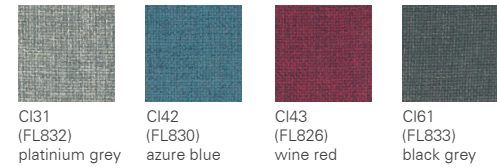
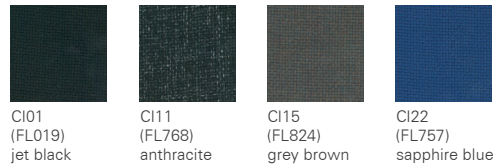

Era

100% Polyester
448 g/rm



Manhattan

100% recycled Polyester
405 g/rm

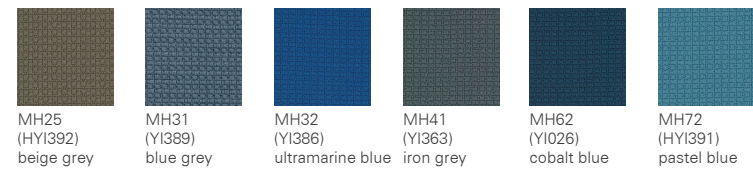
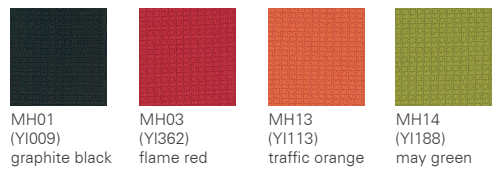

* MH25
Discontinued colour,
availability will be
checked upon request.

Strick

100 % Polyester
580 g/rm

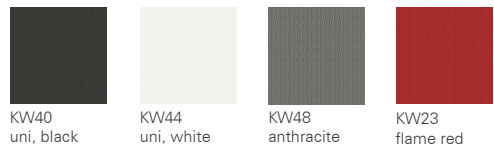

FABRIC COVERS

Fabric group 2

Lucia

100% Polyester
400 g/lfm



5800
(YP009)
black

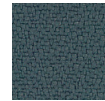

5801
(YP019)
traffic grey

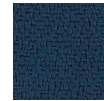

5803
(YP026)
sapphire blue



5805
(YP106)
ruby red

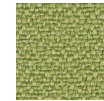

5809
(YP108)
pale green

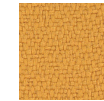

5811
(YP110)
maize yellow

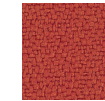

5816
(YP076)
vermillion

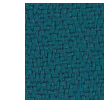

5824
(YP011)
ocean blue



5832
(YP082)
blue

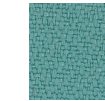

5814
(YP112)
mint turquoise



5823
(YP051)
bordeaux

King

100% Polyester (Trevira CS)
365 g/lfm



KI01
(8033)
black brown



KI03
(4027)
signal red



KI11
(8510)
grey brown

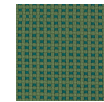

KI14
(7519)
fern green

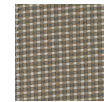

KI15
(2514)
ochre yellow

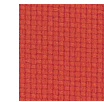

KI43
(3094)
vermillion



KI62
(6617)
night blue

Royal

100% Polyester
490 g/lfm

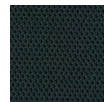

RO01
(PS004)
jet black

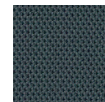

RO11
(PS030)
graphite grey

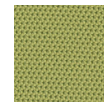

RO14
(PS026)
pale green

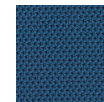

RO22
(PS033)
violet blue

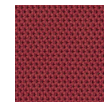

RO53
(PS011)
ruby red

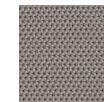

RO61
(PS002)
beige grey

Medley

100% Polyester
510 g/lfm



MD01
(60999)
black grey



MD03
(64019)
traffic red

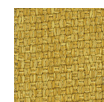

MD06
(62002)
broom yellow

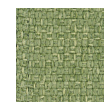

MD14
(68114)
green beige



MD21
(66008)
squirrel grey



MD22
(66009)
violet blue



MD23
(65012)
red lilac



MD31
(60004)
graphite grey

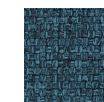

MD32
(66010)
steel blue

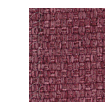

MD43
(64125)
signal red

Amalfi

86% PVC
14% Polyester
910 g/lfm

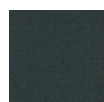

AM01
(008716)
signal black



AM05
(008719)
nut brown



AM06
(008731)
sun yellow



AM07
(008717)
cream



AM12
(014128)
pastel blue

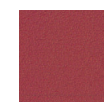

AM13
(008732)
signal red

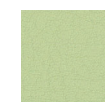

AM14
(014129)
pastel green



AM16
(014131)
zinc yellow



AM17
(008714)
light ivory



AM22
(008720)
steel blue



AM33
(008726)
pastel yellow

Jet

100% Polyester
365 g/lfm

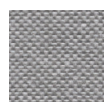

JT01
(9804)
blue grey



JT02
(9610)
pastel turquoise



JT03
(4017)
claret violet



JT04
(9701)
fern green



JT06
(9304)
honey yellow

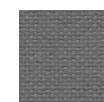

JT11
(8009)
iron grey



JT12
(6007)
turquoise blue



JT14
(9703)
olive green

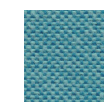

JT22
(9609)
water blue



JT24
(7034)
khaki grey

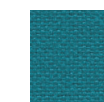

JT32
(6091)
ocean blue

In brackets: Order number of the manufacturer.

FABRIC COVERS

Fabric group 3 (further on the next page)

Fame

95% New wool
5% Polyamide
630 g/rm



FA01
(60999)
jet black

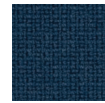

FA02
(66071)
sapphire blue



FA07
(60005)
oyster white



FA13
(64089)
signal red



FA61
(60003)
anthracite grey

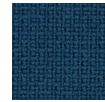

FA62
(67005)
water blue

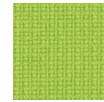

FA64
(68144)
yellow green

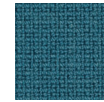

FA72
(67069)
capri blue



FAK3
(64055)
claret violet



FA15
(61135)
pale brown



FA16
(62067)
sulfur yellow



FA21
(60017)
grey blue

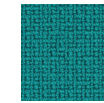

FA24
(67016)
ocean blue

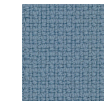

FA32
(66130)
pigeon blue

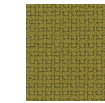

FA44
(68004)
honey yellow

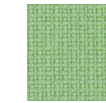

FA54
(68147)
pale green



FA91
(60078)
dusty grey

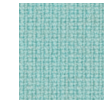

FAB2
(67068)
turquoise blue

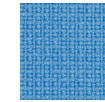

FAC2
(66118)
brilliant blue



FAH3
(64058)
purple red

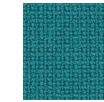

FAI2
(67067)
green blue

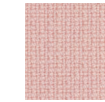

FAJ3
(64169)
light pink

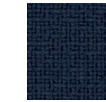

FAA2
(66061)
black blue

Field

100% Polyester (Trevira CS)
450 g/rm



FI03
(662)
carmine red

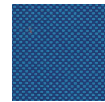

* FI32
(762)
ultramarine blue

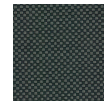

FI41
(182)
black grey



FI51
(192)
black

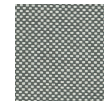

FI81
(132)
graphite grey

* FI32

Discontinued colour, availability will be checked upon request.

Climatex Ultra

72% Cradura™
16% Certified Virgin Wool
12% Redesigning Lenzing FR™
437 g/rm

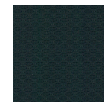

UL01*
(491 008-999)
traffic black



UL02*
(491 008-575)
cobalt blue

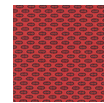

UL03
(491 008-353)
traffic red



UL04
(491 008-696)
patina green

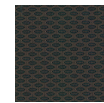

UL05
(491 008-792)
black brown

* These fabrics are also available in

conductive form (for Hero and Goal).

Patina

69% Wool
22% Flax
8% Polyamide
1% Viskose
462 g/rm

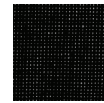

PT01
(PAT20)
jet black

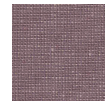

PT02
(PAT43)
pearl blackberry



PT03
(PAT18)
red violet



PT04
(PAT39)
yellow green



PT06
(PAT16)
sand yellow

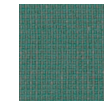

PT11
(PAT32)
water blue

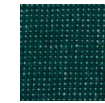

PT12
(PAT05)
ocean blue

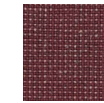

PT13
(PAT42)
claret violet

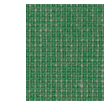

PT14
(PAT28)
patina green

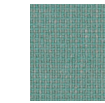

PT22
(PAT01)
turquoise blue

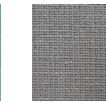

PT32
(PAT12)
dusty grey

FABRIC COVERS

Fabric group 3

Chili

100% recycled Polyester FR
470 g/rm

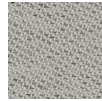

CH01
(60115)
pearl light grey

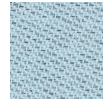

CH02
(66175)
pastel blue

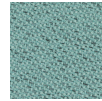

CH04
(68189)
mint turquoise



CH07
(60114)
white aluminium

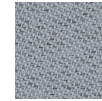

CH11
(60117)
squirrel grey

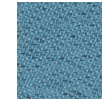

CH12
(66176)
brilliant blue

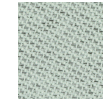

CH14
(68191)
pastel green

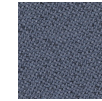

CH21
(60081)
grey blue

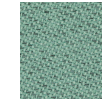

CH24
(68192)
patina green

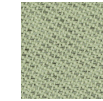

CH34
(68195)
pale green

Remix

90% New wool
10% Worsted
420 g/rm



RE05
(233)
grey beige



RE15
(123)
traffic grey



RE25
(223)
ivory



RE27
(682)
pearl blackberry



RE35
(452)
copper brown

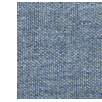

RE42
(733)
azure blue

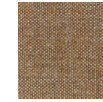

RE45
(252)
olive brown



RE65
(612)
brown beige



RE71
(163)
umbra grey



RE81
(143)
basalt grey



REA1
(692)
black red



RED1
(242)
concrete grey

FABRIC COVERS

High-Performance-Group 4

Synergy

95% New wool
5% Polyamide
560 g/rm

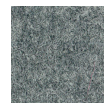

YS01
(LDS16)
quartz grey

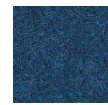

YS02
(LDS62)
violet blue

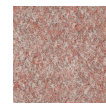

YS03
(LDS74)
light pink



YS04
(LDS46)
pastel green

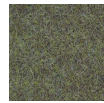

YS25
(LDS48)
olive brown



YS26
(LDS45)
honey yellow

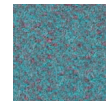

YS32
(LDS56)
pearl gentian blue

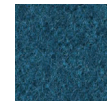

YS34
(LDS59)
green blue

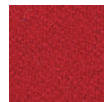

YS73
(LDS86)
signal red

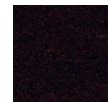

YS93
(LDS88)
black red



YS05
(LDS32)
grey beige

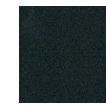

YS11
(LDS27)
traffic black

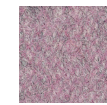

YS13
(LDS07)
pastel violet



YS15
(LDS33)
pale brown



YS16
(LDS28)
lemon yellow

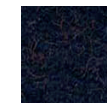

YS22
(LDS61)
purple violet

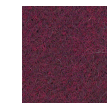

YS23
(LDS87)
purple red

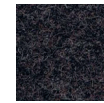

YS35
(LDS34)
grey brown

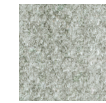

YS41
(LDS08)
traffic grey

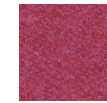

YS43
(LDS36)
red violet

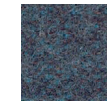

YS44
(LDS58)
black green



YS51
(LDS17)
black grey

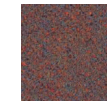

YS53
(LDS76)
pearl pink

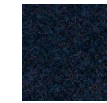

YS54
(LDS60)
ocean blue

PUxx

100% Polyurethane
740 g/rm



PU01
(21.5816)
black grey



PU02
(21.7609)
grey blue



PU03
(21.9533)
antique pink



PU04
(21.6441)
reed green



PU05
(21.7707)
pale brown



PU06
(21.7148)
light ivory



PU07
(21.7136)
oyster white



PU11
(21.7261)
cement grey



PU12
(21.7606)
green blue



PU15
(21.9527)
copper brown



PU22
(21.7608)
ocean blue

Rime

90% New wool worsted
10% Nylon
580 g/rm

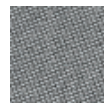

RI01
(151)
signal black

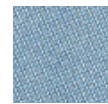

RI02
(721)
azure blue

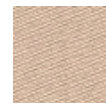

RI03
(521)
deep orange

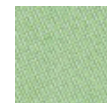

RI04
(921)
may green

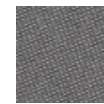

RI05
(641)
pale brown

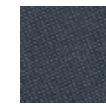

RI11
(791)
black grey



RI13
(621)
strawberry red

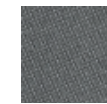

RI15
(271)
grey brown



RI21
(131)
squirrel grey

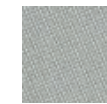

RI31
(231)
olive grey

Discontinued colour,
only available until the
end of 2023

Steelcut Trio 3

90% New wool worsted
10% Nylon
770 g/rm

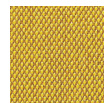

TS06
(453)
yellow flecked

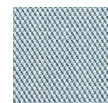

TS27
(713)
window grey



TS37
(124)
tarpaulin grey

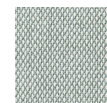

TS47
(113)
light grey

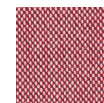

TS53
(636)
traffic red



TS65
(436)
orange brown

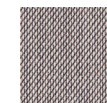

TS75
(616)
grey brown

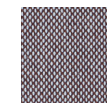

TS85
(336)
nut brown



TS87
(213)
light grey flecked



TSA7
(205)
stone grey

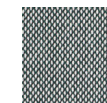

TSB4
(916)
pine green

In brackets: Order number of the manufacturer.

FABRIC COVERS

Leather group 6

Rind-Nappa-leather



0781
signal black

Leather group 7

Semi-Aniline leather*



SA01
signal black



SA07
signal white

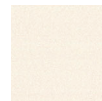

SA17
cream



SA22
grey blue



SAC1
platinum grey



SAE5
ochre brown



SAG5
sepia brown

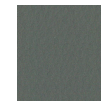

SA51
quartz grey



SA82
pastel blue



SA85
grey beige

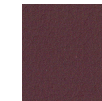

SA93
claret violet

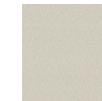

SAA1
pebble grey



SAB1
beige grey

ESD

Duotec ESD

89% Polyacryl
2% Lycra
535 g/rm



9801
black

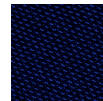

9802
blue



9803
red



9811
grey

Functional fabric

Zaha

100% Polyester
ca. 405 g/rm



ZH01
black



ZH07
white

* Fabric no. available as electronic / OFML data for
Semi-Aniline leather: AS..

In brackets: Order number of the manufacturer.

MESHES/MEMBRANE/INTEGRAL FOAM/FRAME- AND COATING COLOURS/COLOUR FOR PLASTIC PARTS

Meshes knitted

Hero



black
8010



anthracite
8009

Goal-Air



black
8001

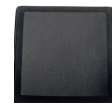

anthracite
8009

JOYCE^{IS3}

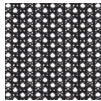

8240
uni, black
KW40



8244
uni, white
KW44

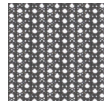

8248
anthracite
KW48

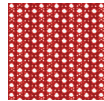

8223
flame red
KW23

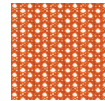

8213
traffic orange
KW13

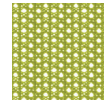

8214
may green
KW14

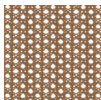

8225
beige grey
KW25

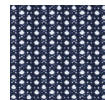

8262
cobalt blue
KW62

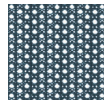

8272
pastel blue
KW72

Cursive: Corresponding mesh cover for the seat.

Softback knitted

JOYCE^{IS3}

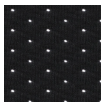

8340
uni, black
KW40



8344
uni, white
KW44

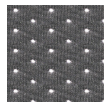

8348
anthracite
KW48

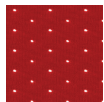

8323
flame red
KW23

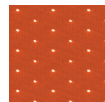

8313
traffic orange
KW13

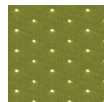

8314
may green
KW14



8325
beige grey
KW25

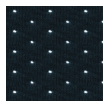

8362
cobalt blue
KW62

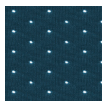

8372
pastel blue
KW72

Cursive: Corresponding mesh cover for the seat.

Membran

AirPad



black
8840



white
8844

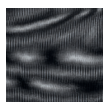

uni, black
8140
MH01

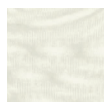

uni, white
8144

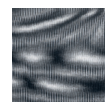

anthracite
8148
MH41

Cursive: Fabric colours as per the Manhattan colour palette.

Mesh

PURE^{IS3}, MOVY^{IS3}, VINTAGE^{IS5}, AIM^{IS1}, EVERY^{IS1}, BUDDY^{IS3}

Mesh

PURE^{IS3}, MOVY^{IS3}, AIM^{IS1}, EVERY^{IS1}, BUDDY^{IS3}

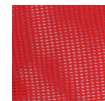

8123
flame red
MH03

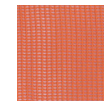

8113
traffic orange
MH13

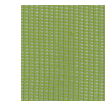

8114
may green
MH14

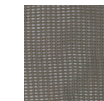

8125
beige grey
MH25

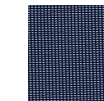

8162
cobalt blue
MH62

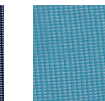

8172
pastel blue
MH72

Cursive: Fabric colours as per the Manhattan colour palette.

Integral foam

KINETIC^{IS5}



black
2000



grey
2002

Frame- and coating colours

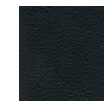

black
..217



brilliant silver
..234



chromed
..324



polished
..304

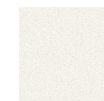

white
..283



brushed silver,
polished
..349

Colour for plastic parts

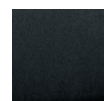

black
3217

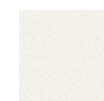

white
3283



fresh yellow
3400



soft red
3401



ice blue
3402



light grey
3261



smart white
3403



anthracite
3231



blue
3206



red
3207



green
3245



yellow
3208



petrol
3A01



grey-blue
3A02



nude
3A03



mustard yellow
3A04

The variations and colours of the models you will find in the pricing table of each product family. The Table also shows the relevant ordering reference number.

SURFACES/COLOURS/ TABLE EDGES

Veneers / Genuine wood



Beech 450 / 430 / 4302A
Maple 451
European cherry 453
Americ. walnut 435 / 455 / 4352A
Oak 434 / 459 / 4342A
Makassar 458
Natural ash 5462

Laminate table tops



Beech natural 41F / 42F
Honey maple 41E / 42E
Light cherry 41H / 42H
Light walnut 41I / 42I
Light oak 41G / 42G



Premium white 41A / 42A / 45A / 4002A
White grey 41B / 42B
Dusty grey 41C / 42C
Black 41D / 42D / 45D
Anthracite 45N
Mineral Co-con, (acrylate-bonded natural mineral) white 44412
Painted opaque white 414

Glass



Clear glass 44400

Multiplex edge



Birch ...7M

The colour and veneer samples shown provide a true representation of the series colours and structures. Wood is a natural product. Veneers with different structures and colours are always used for the production of tables. As a result

complaints about colour and structure deviations caused by the material cannot be accepted.

The variations and colours of the models you will find in the pricing table

of each product family. The Table also shows the relevant ordering reference number.

Table edges

Fascino-2

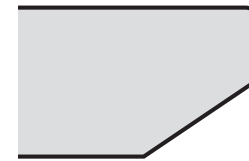

NESTY^{IS3}



Straight edge, ABS (2mm)
Colour as decor



Edge, ABS with rubber protection (R50)



Edge, ABS boatshaped table
Colour for wood veneer
MDF, transparent laquered
Colour for laminate
Single-colour
Laquered same colour

VLEGS^{IS3}



Straight edge, ABS (2mm)

LEMON^{IS5}, LIME^{IS5}



Colour for laminate
single colour: Lacquered same colour

WHAT IF WE FLY



Multiplex edge (2mm)

KINETIC^{IS5}



Edge, ABS

HUB^{IS3}

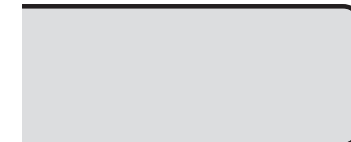

Pods, Benches & Desks: ABS Edge
Side Table Set: Vanished Edge

TANGRAM^{IS5}



Straight edge, black

Headquarters

Interstuhl
Büromöbel GmbH & Co. KG
Brühlstraße 21
72469 Meßstetten-Tieringen, Germany
Tel. +49 (0) 7436 871 0
Fax +49 (0) 7436 871 110
info@interstuhl.de
interstuhl.com

Offices

London (UK) / Showroom
Madrid (Spain) / Showroom
Mexico City (Mexico) / Showroom
Shanghai (China) / Showroom
Chicago (USA)

Production

Germany, Mexico, Slovakia

Representative offices

Vienna (Austria) / Showroom
Copenhagen, Holte (Denmark) / Showroom
Zoeterwoude (The Netherlands) / Showroom
Dubai (UAE) / Showroom
Milano (Italy) / Showroom
Paris (France) / Showroom

**You can find more information about our
subsidiaries, showrooms
and international partners
at interstuhl.com**



Find us online: interstuhl.com

or follow us on:

 [instagram.com/interstuhl_official](https://www.instagram.com/interstuhl_official)

 [pinterest.com/interstuhl](https://www.pinterest.com/interstuhl)

 [linkedin.com/company/interstuhl](https://www.linkedin.com/company/interstuhl)



Technical details subject to change.
Typographical discrepancies possible. 05/22 TN: 1W00_UNT_IAEN
The paper used in the manufacture of this brochure was made from wood
from responsibly managed, sustainable forests or other controlled sources.